



## User Guide



## Dynamic3

HDCP compliant aluminium foldable monitors

---

Technology Serving Design

Danish craftsmanship  
Mediterranean soul

  
ARTHUR HOLM

## TABLE OF CONTENTS

REGULATIONS AND SECURITY	5
SAFETY INSTRUCTIONS	5
SYSTEM DESCRIPTION	7
INSTALLATION INSTRUCTIONS	13
BEFORE INSTALLATION	18
BEFORE SHIPPING	19
CONTROLS	20
OSD MENU	22
ISD MENU	25
INPUT CONNECTORS	31
AHnet PROTOCOL	33
VIDEO SIGNALS	37
AHLink	38
INFORMATION ON DISPOSAL	42
WARRANTY TERMS AND CONDITIONS	43

## **WELCOME**

Thank you very much for purchasing an Arthur Holm product.

Please, read these installation and operating instructions carefully and keep them in a safe place for future consultations.

We remain at your entire disposal if you have any suggestions.

**Henrik Holm**

General Manager

hholm@albiral.com

## **ABOUT US**

### **The Company**

Arthur Holm has its origins in the Danish furniture designer Jorgen Alex Jensen, who was active during the sixties and the seventies. His design inspiration and his concept of ergonomics have been continued by his family, who is the design force behind Arthur Holm product range. The result of combining Scandinavian design tradition with Mediterranean creativity, flexibility and emotion is a wide product range built on more than 25 years of craftsmanship.

Arthur Holm offers a professional product range where tomorrow's technology is shaped into valued materials with design flexibility and customisation, specially created to enhance communication in reception, collaboration, conference and meeting areas.

### **The art of customisation**

Arthur Holm offers a range of ingenious products whose designs are based on quality materials and the latest technology. Products which endow meeting and conference rooms with silent, ergonomic, innovative and aesthetic solutions that integrate into the furniture, hang from the walls as works of art or are used as interactive points of information.

### **The world of Arthur Holm**

Arthur Holm offers a selection of unique, elegant, versatile, flexible and ergonomic products that are being used in meeting and conference rooms, reception areas, auditoriums and public zones of leading companies throughout the world.

The numbers speak for themselves! We currently own 33 product patents, have presence in over 45 countries with products and solutions in more than 25,000 installations.

It will be our pleasure to work with you, designing your unique and personalised environment. Our broadcast electronic engineers will provide the latest technology while our design team will offer you the most exclusive appearance.

Our team puts its heart, passion and pride in all our designs.

## REGULATIONS AND SECURITY



**ATTENTION:** Do not disassemble or modify the device in any way. This symbol warns of the presence of dangerous un-insulated voltages inside some of the components, of sufficient magnitude to expose people to risk of electronic shock.



This symbol draws attention to important use and maintenance instructions in the manual that accompanies the unit.



This symbol indicates that the equipment conforms to the norms established by the European Community.



This symbol indicates D.C. current.



This symbol indicates that the equipment has some potential entrapment hazard parts.

## SAFETY INSTRUCTIONS

### Plugs

- Do not dismantle any part of the monitor power connector.
- Disconnect the power plug from the AC outlet when the monitor is not going to be used for an indefinite period of time.

### Power and extensions cords

- Use the appropriate power cord with the correct plug type.
- Do not overload wall outlets or power cords.
- Make sure the total ampere passed through an extension cord does not exceed the maximum allowed by the cable used.
- Do not place anything on the power cord.
- Do not locate this product where a person may walk or trip over the cord.

## SAFETY INSTRUCTIONS



Wiring connected to hazardous voltage requires installation by qualified personnel or the use of ready-made flexible cables.



For your security, your equipment must be connected to an electrical outlet with grounding connection protection.

Since the plug is used to disconnect the device, the operating electrical outlet must be in an easily accessible place.

### Environment

- Install the equipment on an elevated, flat surface.
- Install the equipment in a ventilated area.
- Avoid exposing the equipment to:
  - Rain or water
  - Excessive heat, cold or humidity
  - Area exposed to direct sunlight
  - Dirty areas
  - Equipment generating strong magnetic fields
- Avoid placing open containers of liquid, near the equipment.
- Keep a minimum distance of 30 mm in order to have good ventilation.
- Never place above the device any sources of flames such as lighted candles, etc.
- If you are using the device in extreme weather conditions and/or tropical climates, the equipment should be installed in a room which ensures a reasonable level of temperature and humidity.
- To prevent damage the equipment must be firmly anchored to the surface, as shown on the installation instructions.

## SYSTEM DESCRIPTION

### General

Dynamic3 is a motorised product range which is available in 2 different versions, always keeping a low profile inside the desk and designed for a perfect horizontal integration in the furniture. The D3 range opens and folds, whereas the D3R range opens, folds and rotates 180°.

The aluminium monitor housing rises and leans, has an additional 180° rotation movement, and retracts inside the work surface in 2 different positions: with the monitor oriented up or down (D3R). The screen's lifting system automatically activates the elevation of a tray where a keyboard and mouse can be placed.

### Highlights

- No loss of work space
- Low profile monitor enclosure leaving enough space ergonomic work position
- AH-AMMC Auto Mechanical Movement Calibration
- Keyboard and mouse storage space
- 2 working positions: vertical and horizontal (with screen facing up) (D3R)
- Opens, folds down and rotates 180° (D3R)
- Automatic image flip (D3R)
- Patented synchronised tray lift movement
- Milled aluminium housing and cover plate
- Floating security sensor
- Wireless connectivity for setup and control

# SYSTEM DESCRIPTION

## Available Models

MODEL	DESCRIPTION
AH15D3RHDGA	<p>                     HDCP compliant 15,6" Full HD foldable monitor with horizontal and vertical working positions. Can work in a horizontal position levelled with the desk surface or in a vertical position with 20° of variable inclination. The monitor can rotate 180° and can be folded with the screen facing down. Both the monitor housing and cover plate are made of anodised aluminium. The monitor is protected by a 3 mm. double-sided antireflective black edged glass. DVI-I and DVI-D inputs. Interactive Setup Display allowing the control, setup and diagnose of the monitors. Monitors provide RS-422 I/O allowing the remote control of movements, speeds, safety settings, brightness, contrast and backlight. The monitors are equipped with AH-AMMC: an auto mechanical movement calibration system.                 </p>
AH15D3HDGA	<p>                     HDCP compliant 15,6" Full HD foldable monitor with vertical working position. Can work in a a vertical position with 20° of variable inclination. The monitor can be folded with the screen facing down. Both the monitor housing and cover plate are made of anodised aluminium. The monitor is protected by a 3 mm. double-sided anti-reflective black edged glass. DVI-I and DVI-D inputs. Interactive Setup Display allowing the control, setup and diagnose of the monitors. Monitors provide RS-422 I/O allowing the remote control of movements, speeds, safety settings, brightness, contrast and backlight. The monitors are equipped with AH-AMMC: an auto mechanical movement calibration system                 </p>
AH17D3RHDGA	<p>                     HDCP compliant 17,3" Full HD foldable monitor with horizontal and vertical working positions. Can work in a horizontal position levelled with the desk surface or in a vertical position with 20° of variable inclination. The monitor can rotate 180° and can be folded with the screen facing down. Both the monitor housing and cover plate are made of anodised aluminium. The monitor is protected by a 3 mm. double-sided antireflective black edged glass. DVI-I and DVI-D inputs. Interactive Setup Display allowing the control, setup and diagnose of the monitors. Monitors provide RS-422 I/O allowing the remote control of movements, speeds, safety settings, brightness, contrast and backlight. The monitors are equipped with AH-AMMC: an auto mechanical movement calibration system.                 </p>



# SYSTEM DESCRIPTION

## Available Models

MODEL	DESCRIPTION
AH17D3HDGA	<p>HDCP compliant 17,3" Full HD foldable monitor with vertical working position. Can work in a in a vertical position with 20° of variable inclination. The monitor can be folded with the screen facing down. Both the monitor housing and cover plate are made of anodised aluminium. The monitor is protected by a 3 mm. double-sided anti-reflective black edged glass. DVI-I and DVI-D inputs. Interactive Setup Display allowing the control, setup and diagnose of the monitors. Monitors provide RS-422 I/O allowing the remote control of movements, speeds, safety settings, brightness, contrast and backlight. The monitors are equipped with AH-AMMC: an auto mechanical movement calibration system.</p>
AH19D3RHDGA	<p>HDCP compliant 18,5" Full HD foldable monitor with horizontal and vertical working positions. Can work in a horizontal position levelled with the desk surface or in a vertical position with 20° of variable inclination. The monitor can rotate 180° and can be folded with the screen facing down. Both the monitor housing and cover plate are made of anodised aluminium. The monitor is protected by a 3 mm. double-sided antireflective black edged glass. DVI-I and DVI-D inputs. Interactive Setup Display allowing the control, setup and diagnose of the monitors. Monitors provide RS-422 I/O allowing the remote control of movements, speeds, safety settings, brightness, contrast and backlight. The monitors are equipped with AH-AMMC: an auto mechanical movement calibration system.</p>
AH19D3HDGA	<p>HDCP compliant 18,5" Full HD foldable monitor with vertical working position. Can work in a in a vertical position with 20° of variable inclination. The monitor can be folded with the screen facing down. Both the monitor housing and cover plate are made of anodised aluminium. The monitor is protected by a 3 mm. double-sided anti-reflective black edged glass. DVI-I and DVI-D inputs. Interactive Setup Display allowing the control, setup and diagnose of the monitors. Monitors provide RS-422 I/O allowing the remote control of movements, speeds, safety settings, brightness, contrast and backlight. The monitors are equipped with AH-AMMC: an auto mechanical movement calibration system.</p>

# SYSTEM DESCRIPTION

## Available Models

MODEL	DESCRIPTION
AH22D3RHDGA	<p>HDCP compliant 21,5" Full HD foldable monitor with horizontal and vertical working positions. Can work in a horizontal position levelled with the desk surface or in a vertical position with 20° of variable inclination. The monitor can rotate 180° and can be folded with the screen facing down. Both the monitor housing and cover plate are made of anodised aluminium. The monitor is protected by a 3 mm. double-sided antireflective black edged glass. DVI-I and DVI-D inputs. Interactive Setup Display allowing the control, setup and diagnose of the monitors. Monitors provide RS-422 I/O allowing the remote control of movements, speeds, safety settings, brightness, contrast and backlight. The monitors are equipped with AH-AMMC: an auto mechanical movement calibration system.</p>
AH22D3HDGA	<p>HDCP compliant 21,5" Full HD foldable monitor with vertical working position. Can work in a in a vertical position with 20° of variable inclination. The monitor can be folded with the screen facing down. Both the monitor housing and cover plate are made of anodised aluminium. The monitor is protected by a 3 mm. double-sided anti-reflective black edged glass. DVI-I and DVI-D inputs. Interactive Setup Display allowing the control, setup and diagnose of the monitors. Monitors provide RS-422 I/O allowing the remote control of movements, speeds, safety settings, brightness, contrast and backlight. The monitors are equipped with AH-AMMC: an auto mechanical movement calibration system.</p>

# SYSTEM DESCRIPTION

## Options

<b>AH15D3RHDGA</b> <b>AH15D3HDGA</b>	<b>AH17D3RHDGA</b> <b>AH17D3HDGA</b>	<b>AH19D3RHDGA</b> <b>AH19D3HDGA</b>	<b>AH22D3R16GA</b> <b>AH22D316GA</b>
<b>CL (Min.5 units)</b> Laser engraved logo	<b>CL (Min.5 units)</b> Laser engraved logo	<b>CL (Min.5 units)</b> Laser engraved logo	<b>CL (Min.5 units)</b> Laser engraved logo
<b>UI</b> Underneath installation	<b>UI</b> Underneath installation	<b>UI</b> Underneath installation	<b>UI</b> Underneath installation
<b>TS150HDG</b> Projected capacitive multitouch screen	<b>TS170HDG</b> Projected capacitive multitouch screen	<b>TS190HDG</b> Projected capacitive multitouch screen	<b>TS2216G</b> Projected capacitive multitouch screen
<b>DTalk (Min.10 units)</b> Built in DynamicTalkM	<b>DTalk (Min.10 units)</b> Built in DynamicTalkM	<b>DTalk (Min.10 units)</b> Built in DynamicTalkM	<b>DTalk (Min.10 units)</b> Built in DynamicTalkM
			<b>USBCD3 (Min.10 units)</b> USB camera
<b>CCUSBCD3</b> USB passthrough	<b>CCUSBCD3</b> USB passthrough	<b>CCUSBCD3</b> USB passthrough	<b>CCUSBCD3</b> USB passthrough
<b>CC2USBCD3</b> 2 USB passthroughs	<b>CC2USBCD3</b> 2 USB passthroughs	<b>CC2USBCD3</b> 2 USB passthroughs	<b>CC2USBCD3</b> 2 USB passthroughs
<b>KM</b> Wired keyboard and wireless mouse	<b>KM</b> Wired keyboard and wireless mouse	<b>KM</b> Wired keyboard and wireless mouse	<b>KM</b> Wired keyboard and wireless mouse
<b>AHISBD3PT (Min.10 units)</b> HDMI retractable passthrough	<b>AHISBD3PT (Min.10 units)</b> HDMI retractable passthrough	<b>AHISBD3PT (Min.10 units)</b> HDMI retractable passthrough	<b>AHISBD3PT (Min.10 units)</b> HDMI retractable passthrough
<b>AHDL</b> DynamicLoop	<b>AHDL</b> DynamicLoop	<b>AHDL</b> DynamicLoop	<b>AHDL</b> DynamicLoop
<b>AHDSS (Min.10 units)</b> DynamicShare	<b>AHDSS (Min.10 units)</b> DynamicShare	<b>AHDSS (Min.10 units)</b> DynamicShare	<b>AHDSS (Min.10 units)</b> DynamicShare
<b>AHHC (Min.10 units)</b> HDMI fixed	<b>AHHC (Min.10 units)</b> HDMI fixed	<b>AHHC (Min.10 units)</b> HDMI fixed	<b>AHHC (Min.10 units)</b> HDMI fixed
<b>AHDSPB</b> Priority	<b>AHDSPB</b> Priority	<b>AHDSPB</b> Priority	<b>AHDSPB</b> Priority
<b>AHHC (Min.10 units)</b> HDMI fixed	<b>AHHC (Min.10 units)</b> HDMI fixed	<b>AHHC (Min.10 units)</b> HDMI fixed	<b>AHHC (Min.10 units)</b> HDMI fixed
<b>CABD3 (Min.10 units)</b> Black anodised	<b>CABD3 (Min.10 units)</b> Black anodised	<b>CABD3 (Min.10 units)</b> Black anodised	<b>CABD3 (Min.10 units)</b> Black anodised
<b>GFD3 (Min.10 units)</b> Gold finish	<b>GFD3 (Min.10 units)</b> Gold finish	<b>GFD3 (Min.10 units)</b> Gold finish	<b>GFD3 (Min.10 units)</b> Gold finish
<b>CPD3 (Min.10 units)</b> Painted	<b>CPD3 (Min.10 units)</b> Painted	<b>CPD3 (Min.10 units)</b> Painted	<b>CPD3 (Min.10 units)</b> Painted

## SYSTEM DESCRIPTION

### Box Contents

Before the installation of your monitor, please check the contents of the shipping box, it must contain the following items:

- Monitor
- Power cord
- Remote control
- Power supply 100-2 40Vac, 50-60Hz. Output 12V
- User guide

**Important note:** This device can only work with the power supply included in the shipping box. This power supply can not be replaced by any other rather than the original one.

## INSTALLATION INSTRUCTIONS

### Dynamic3UI

The Dynamic 3 monitor is available in a special version that is prepared to be mounted from below the table with a veneer finishing on the back of the monitor to match the table. The special version is supplied without aluminium cover frame and buttons.

Included in this version are all necessary brackets and a cable of 1,5m [4,9ft] with a GPI connector for a remote control.

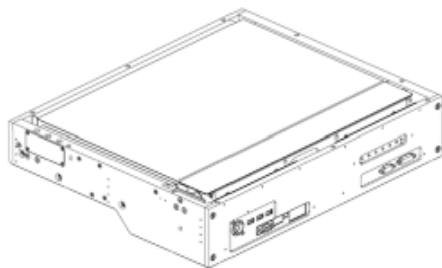

### Veneer

To veneer the back of the monitor the dimensions are specified in general dimensions. Different materials can be used to veneer the monitor, maximum thickness of the veneer 4mm [0,16"] and maximum weight 1Kg. (veneer thickness + glue < 4).

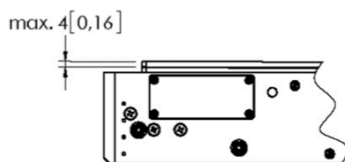

### For models with ROTATION

To veneer the back of the monitor the dimensions are specified in general dimensions.

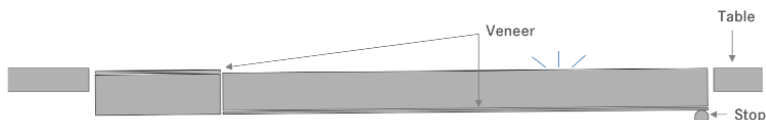

## INSTALLATION INSTRUCTIONS

### Glued

The veneer can be glue or taped to the monitor housing and protection plate. When veneering the monitor the pressure applied must not exceed 5Kg without the security screws correctly placed. With security screws the applied pressure must not exceed 12Kg.

The pressure over the protection cover may not exceed 3Kg.

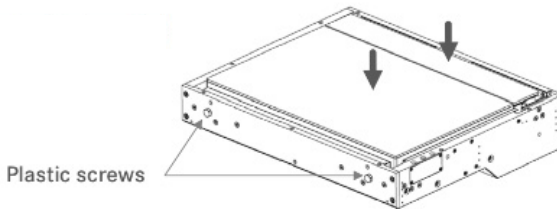

### Pattern Hole

Pattern hole dimensions for milling are specified in the general dimensions for each reference. The milling of the furniture has to be done from below.

### Attention

Manipulation of the product should be avoided, no stress should be applied to the product except from the instructions given in this document. Cutting, drilling, soldering, adding of electrical and mechanical components can cause danger and should be avoided by all mean. Not complying with these direction will result in a lost of the Arthur Holm warranty. Albiral Display Solution S.L. shall not be held liable for any loss or injury incurred as a result of modifications made to goods by anyone other than the supplier or the supplier's authorised representative without the supplier's written permission. Such modifications shall be deemed to terminate any further guarantee obligations.

# INSTALLATION INSTRUCTIONS

## Mounting table brackets

Mount the table brackets below the table using the holes indicated on pattern hole drawing. The screws (x6) depend on the table material; the weight of the monitor is up to 17Kg.

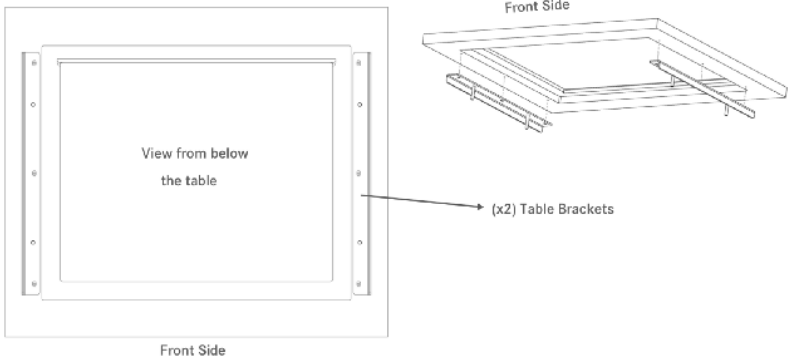

## Mounting the monitor brackets

Mount the monitor brackets on each side of the monitor using tapping screws provided.

Distance "A" should be 5mm [0,197"] more than the table thickness, minimum 20mm [0,787"] and maximum 45mm [1,77"]

Mount the vertical adjustment screws on to the monitor bracket so the screw is flushed with the upper side of the monitor bracket.

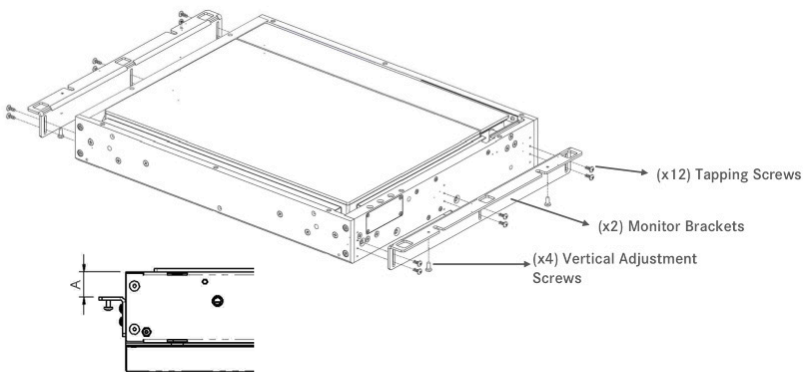

## INSTALLATION INSTRUCTIONS

### Mounting the monitor

Mount two nuts on to one of the table brackets as indicated on the drawing.

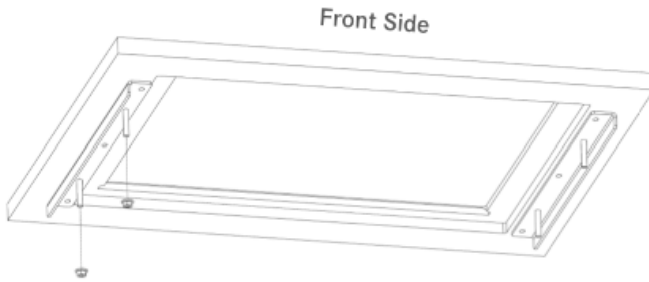

Insert the monitor and mount the remaining two nuts to the upper side monitor bracket.

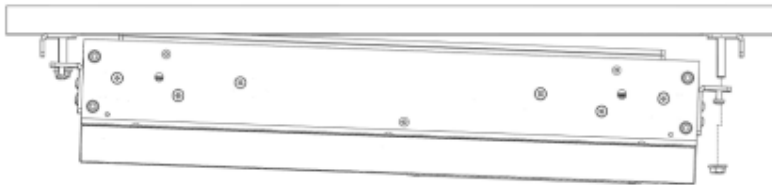

Tighten each nut gradually until the monitor surface is levelled with the table surface.





## INSTALLATION INSTRUCTIONS

### Fine centring of the monitor

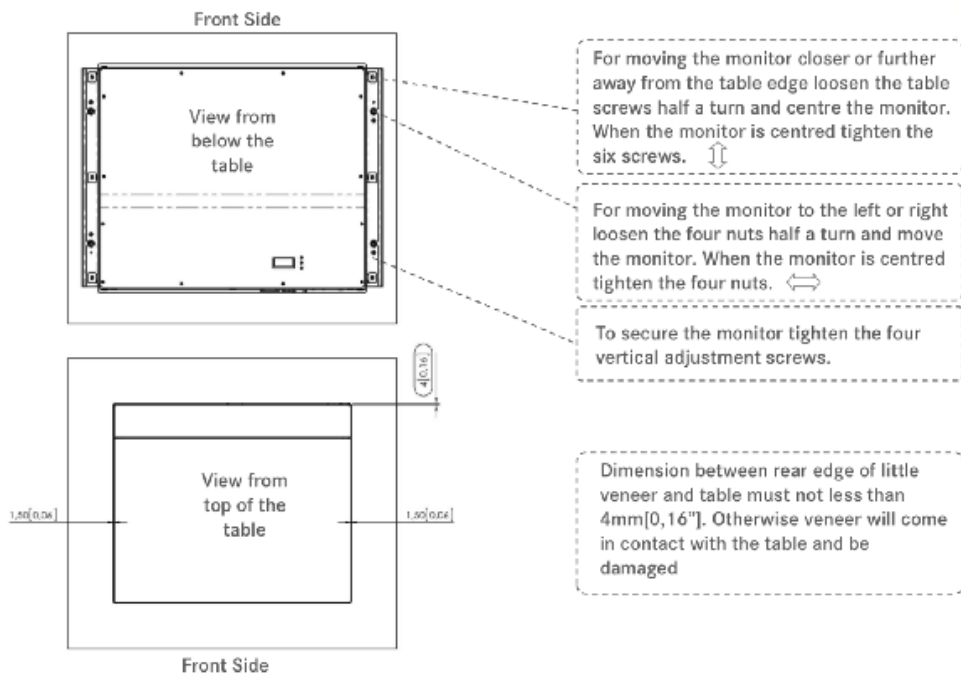

### Remote control

A remote control with 1,5m [4,9ft] cable length is included to operate the Dynamic3.

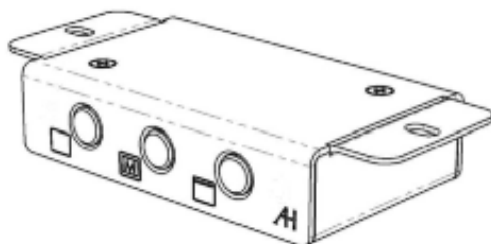

## BEFORE INSTALLATION

Make sure to follow these steps before installing the device:

Remove the 2 lateral transport plastic screws M8x30.

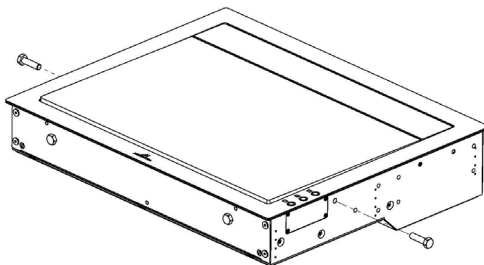

Remove the 2 frontal transport plastic screws M8x30.

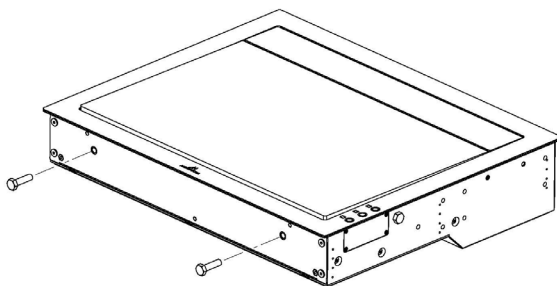

Dynamic3 is ready to be installed.

# BEFORE SHIPPING

Follow the next steps to pack the device for a safe shipment:

For a safety shipment all screws must be of plastic. Otherwise Albiral Display Solutions S.L. is not responsible for damage caused during transport.

Close the monitor carefully by hand to the position shown in the next figure:

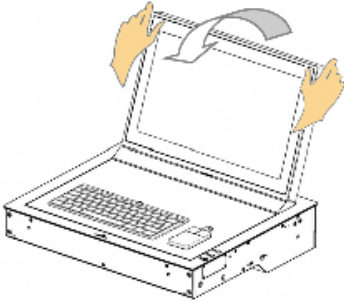

Hold the monitor with the hand between the frame and the monitor housing. At the same time insert the 2 plastic screws (M8x40) entirely. To close the monitor, leave the monitor housing and it will fall to lean on the two plastic screws.

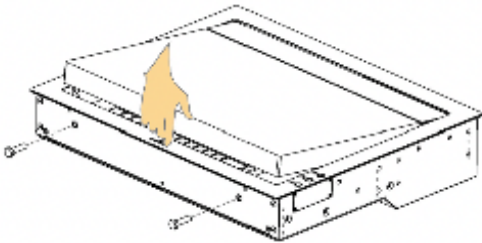

Insert the two lateral plastic screws (M8x30) starting by the righthand side, screw the plastic screw into the frame until it touches the aluminium housing without moving the aluminium housing (very fine tolerances). Hereafter insert the lefthand side plastic screw by screwing it until it touches the aluminium housing.

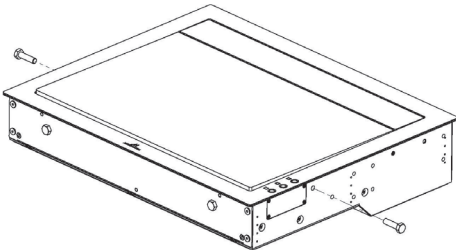

## CONTROLS

### Monitor movement controls

Three buttons are placed on the upper cover plate:

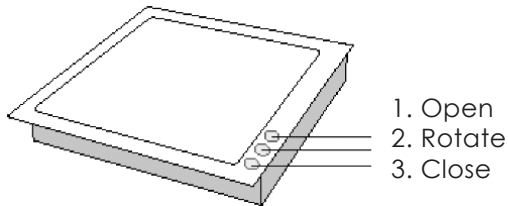

1. Raising the monitor: To raise and tilt the monitor, press the open button (1) on the right hand side of the cover plate. To adjust the angle, press and hold this button (1) while the monitor is open; the screen will slowly move between  $90^{\circ}$  to  $110^{\circ}$ . When the screen is at the desired tilt angle, please release the button (1). To memorise this position, please press the middle button (2) for 2 seconds.
2. Rotating the monitor (D3R): To fold down the monitor with the screen facing up, press the middle button (2). In this position the screen is upwards and it can be used in horizontal position, levelled with the desk. It is recommended that there are no objects nor parts of the body that could obstruct the movements of the display.
3. Folding the monitor: To fold down the monitor with the screen in downwards position, press the close button (3). It is recommended that there are no objects nor parts of the body that could obstruct the movements of the display.

# CONTROLS

## Remote control

POWER	Switch ON/OFF the monitor
MENU	Activates the OSD menu on screen
UP	Control up on the OSD menu
DOWN	Control down on the OSD menu
LEFT	Control left on the OSD menu
RIGHT	Control right on the OSD menu
OK	Selects the function on the OSD menu. When the OSD menu is not active on screen, selects the input source

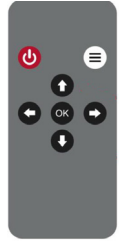

## OSD MENU

### Accessing the menu system

- With the OSD off, push the MENU button to activate the main OSD menu.
- Press the UP and DOWN buttons to move from one function to another. Please refer to the following sections below to view a complete list of all the functions available for the monitor.
- Press the OK button to confirm.
- When a function is selected, press the LEFT and RIGHT buttons in order to change the parameter of the function.

Press the MENU button to access to the main menu.

### Picture

Picture Mode: Adjusts the mode of the image

- Dynamic
- Standard
- Mild
- User: Contrast - Brightness - Colour - Sharpness - Tint

Colour Temperature: Adjusts the colour of the image

- Cool
- Medium
- Warm
- User: Red - Green - Blue

## OSD MENU

Aspect Ratio: Adjusts the image aspect on screen

- 4:3
- 16:9
- Zoom1
- Zoom2
- Just scan

Noise Reduction: Adjusts the image noise filter

- Off
- Low
- Medium
- High
- Default

Screen: (Only for analogue signals)

- Auto Adjust
- Horizontal Position
- Vertical Position
- Size
- Phase

Backlight: Adjusts the backlight screen's level

Colour Range: Adjusts the colour range

- 0 - 255
- 16 - 235

## OSD MENU

### Option

Language: OSD language selection

Restore Factory Default: Adjusts the parameters to the initial factory parameters

Blending: OSD window transparency

- Low
- Medium
- High
- Off

OSD Duration: Adjusts the time that the OSD menu window remains on the screen

Software Update (USB): Port to use for firmware's upgrade.

Mirror:

0. Image with no flip
1. Vertical flip
2. Horizontal flip
3. Rotate



## ISD MENU

The Interactive Setup Display is an LCD screen located at the monitor casing inside the desk that allows the setup and provides useful diagnose and historical data of the device.

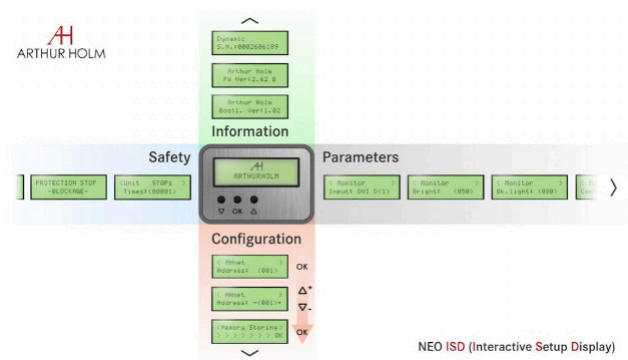

- To start using it -

### • WELCOME DISPLAY & DATA :

#### 1) Bootloader Version

The display will show a Bootloader Version message (example: Bootl. Ver: 1.01). Bootloader is a program which allows the system to be able to update itself. The ISD has a Bootloader and therefore is capable of updating to new versions in order to constantly improve the user experience.

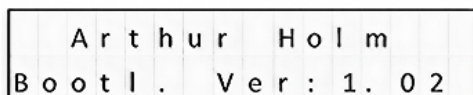

## ISD MENU

### 2) FirmWare

Data that refers to the firmware version (FW) of the equipment (example: FW Ver = 1.32). If you wish to update the FW version, please contact us.

```
  A r t h u r   H o l m  
F W V e r : 1 . 2 6
```

### 3) Serial Number

Serial number of the device (example: serial number of the device = 02658748). The serial number is stored inside each device.

```
D y n a m i c _ 2  
S . N . : 0 1 2 3 4 5 6 7 8 9
```

The serial number can also be obtained via AHnet and AHlink.

- OSD MENU -

## · AHNET (GENERAL PROTOCOL)

### CONTROLS

· The ISD will show the AHnet address which will be accompanied by an acoustic signal "BEEP" (example: Address: (001)). Once the signal has been heard, the "UP & DOWN" buttons will allow the user to scroll through all the variety of menus that the device contains. To enter into any specific menu, simply press the "OK" button.

```
<  A H n e t      >  
A d d r e s s :   ( 0 0 1 )
```

· How to modify the values within each menu? The values can be selected through the "UP & DOWN" buttons. To save the selected value, press the "OK" button or wait 3 seconds for it to be automatically saved.

```
<  A H n e t      >  
A d d r e s s :   - ( 0 0 1 ) +
```

The connection through RS422 allows the control of up to 30 devices per line. The last device (an only the last one) needs to have the termination activated.

## ISD MENU

### · MENUS GENERAL INFORMATION

#### 1) AHnet - Adress

The address must be set from 1 to 60.

```
<  A H n e t  >  
A d d r e s s :   ( 0 0 1 )
```

#### 2) VIDEO INPUT SELECTION

The device provides the following inputs:

DVI1 = DVI-I (DVI-A and DVI1-D)

DVI2= DVI-D (DVI-2D)

This menu allows the selection of 1 of these 3 inputs.

```
<  M o n i t o r  >  
I n p u t :   D V I _ D ( 1 )
```

#### 3) MONITOR BRIGHTNESS

Brightness level (0 – 100).

```
<  M o n i t o r  >  
B r i g h t :   ( 0 5 0 )
```

#### 4) MONITOR CONTRAST

Contrast level (0 – 100).

```
<  M o n i t o r  >  
C o n t r a s t :   ( 0 5 0 )
```

## ISD MENU

### 5) MONITOR BACKLIGHT

Backlight level (0 – 100).

```
< M o n i t o r >  
B k . l i g h t : ( 0 5 0 )
```

### 6) POSITION

It is a diagnostic option that informs about the position of the device.

```
< M o n i t o r >  
P o s i t i o n : ( 0 2 3 )
```

### 7) SENSORS INFORMATION

It is a diagnostic option that informs about the internal state of the sensors.

```
S 1 | 2 | 3 | 4 | 5 | 6 | 7 | 8  
I 0 | 1 | 1 | 1 | 1 | 1 | 1 | 1
```

### 8) AHnet - INFORMATION

This menu is useful for programing and diagnose.

It provides information about the AHnet command that has been received by the device.

Example: AHnet = 0 (FA) 1 (01) 2 (01) 3 (01) 4 (00)

```
A H n e t : 0 ( F A ) 1 ( 0 1 )  
2 ( 0 1 ) 3 ( 0 1 ) 4 ( 0 0 )
```

## ISD MENU

### 9) UNIT OPENS

It is a diagnostic option that provides historical data.

It is very useful to analyze how the device has been used during its lifecycle and it provides information about how many movements the device has done.

```
< U n i t   O p e n i n g s   >  
T i m e s : ( 0 0 0 0 0 )
```

### 10) UNIT STOPS

It is a diagnostic option that provides historical data. It is very useful to analyze how the device has been used during its lifecycle.

It provides information about the number of times that the device has been protected and made emergency stops.

```
< U n i t   S T O P s   >  
T i m e s : ( 0 0 0 0 0 )
```

### 11) SERIAL NUMBER

Provides the device's serial number.

```
< S e r i a l   N u m b e r   >  
S . N . : 0 1 2 3 4 5 6 7 8 9
```

The serial number can also be obtained via AHnet and AHlink.

### 12) MONITOR DOWN

Only use this function as per manufacturer advice.

```
< M o n i t o r   D O W N   >  
O n l y   f o r   S E R V I C E
```

# ISD MENU

## 13) AUTO ADJUST

Auto Mechanical Movement Calibration (AH-AMMC).

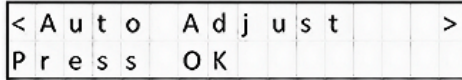

Protocol activation: the device will make a consecutive movements series that must not be interrupted. The system will calibrate the speed and protection thresholds.

## 14) AHLINK

Activates AHLINK.

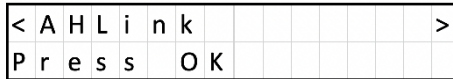

## FIRMWARE UPDATE

To update the FW version.

To start the update, connect a PC with the APP AH\_FW (Device Setting Tool) to the device through the USB port.

Proceed with the following steps:

- Unplug the PSU
- Wait for 1 minute
- Press and hold the "OK" button
- Plug in the PSU
- A message will appear on the LCD screen when the connection is ready
- Start updating the AH\_FW

**How are you doing? Easy, right?**

Now you just have to start enjoying your device 😊

# INPUT CONNECTORS

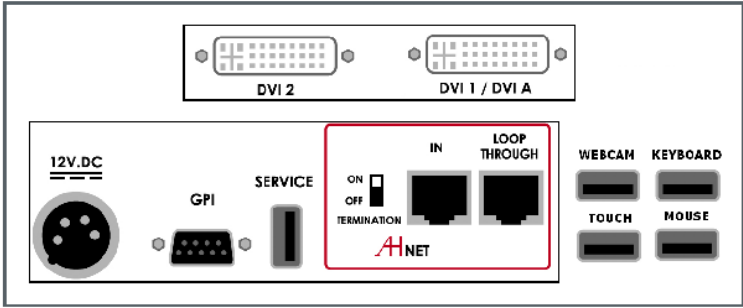

**12V D.C.** : Power supply input connector. XLR-4 connector.

- 1,2: Ground
- 3,4: 12Vdc

**GPI:** Monitor external contact close control. SubD9 female.

1. GPI1 +
  2. GPI1 -
  3. GPI2 +
  4. GPI2 -
  5. GPI3 -
  6. GPI3 +
  7. N.C.
  8. +12Vdc (600mA max.)
  9. Ground:
- Use GPI1 (1:12Vdc, 2: Ground) to open the monitor (pulse signal)
  - Use GPI2 (3:12Vdc, 4: Ground) to close the monitor with the face up (D3R) (pulse signal)
  - Use GPI3 (6:12Vdc, 5: Ground) to close the monitor (pulse signal)

**Termination:** Activate (ON) the termination. Only on the last unit of the RS422 bus.

**AHnet:** RJ45 CAT6 connector for addressable RS422 control. There is a loop through connector to use as signal RS422 output. Up to 30 monitors can be connected on the same RS422 bus.

**USB:** USB connector for touch screen, keyboard and mouse and webcam. This connector is active depending of the monitor model.

## INPUT CONNECTORS

**DVI 1/ DVI A:** DVI-I input signal. Connect a DVI (digital) input signal and select DVI 1 on the OSD monitor menu. Use a DVI to VGA adaptor to connect an ARGB (analogue) input signal and select DVI-A on the OSD monitor menu.

**DVI 2:** DVI-D input signal. Connect a DVI (digital) input signal and select DVI 2 on the OSD monitor menu.

- Use high quality DVI cables with 2m maximum length.



# AHnet PROTOCOL

## Communications protocol

COMMUNICATION	RS422
CONNECTION	RJ45
WIRING	CAT-6

## Speed and configuration

BAUD RATE	38400
DATA BITS	8
PARITY	NONE
STOP BITS	1

## Wiring Diagram

- 1. Data TX +
- 2. Data TX -
- 3. Data RX +
- 4. NC
- 5. NC
- 6. Data RX -
- 7. NC
- 8. NC



RJ-45

## Connection

PINS 1 & 2	The units respond
PINS 3 & 6	The units receive instructions

Protocol to control the monitor by addressable RS422 bus.  
You can connect up to 30 monitors on the same RS422 bus.  
You can use an AH ERT interface, to control the RS422 bus.  
The units should have a set address and the address must start by 1.  
Maximum cable length between ends: 500 m/1 640 ft.

# AHnet PROTOCOL

## AHnet protocol

Uses 5 bytes communication:

<b>BYTE 0</b>	START BYTE
<b>BYTE 1</b>	ADDRESS BYTE
<b>BYTE 2</b>	COMMAND BYTE
<b>BYTE 3</b>	VALUE 1
<b>BYTE 4</b>	VALUE 2

## Commands

COMMAND	DESCRIPTION	RESPONSE
FA XX 01 01 00	OPEN	FB XX 01 01 00
FA XX 01 00 00	CLOSE SCREEN DOWNWARDS	FB XX 01 00 00
FA XX 01 02 00	CLOSE SCREEN FACE UP (D3R)	FB XX 01 02 00
FA XX 01 03 00	OPEN MONITOR 90°	FB XX 01 03 00
FA XX 02 01 00	SCREEN ON	FB XX 02 01 00
FA XX 02 00 00	SCREEN OFF	FB XX 02 00 00
FA XX 03 01 00	DVI-A SELECTION	FB XX 03 01 00
FA XX 03 00 00	DVI-1 SELECTION	FB XX 03 00 00
FA XX 03 03 00	DVI-2 SELECTION	FB XX 03 03 00
FA XX 04 01 00	BUTTON LOCK	FB XX 04 01 00
FA XX 04 00 00	BUTTON UNLOCK	FB XX 04 00 00
FA XX 14 00 00	INQUIRY CONTROL BYTE	FB XX 14 CB1 CB2

XX      Number of the monitor address. Up to 30 monitors for each RS422 BUS

CB1     Response in 8 bites of the monitor status

CB2     Response in 8 bites of the monitor status

# AHnet PROTOCOL

## CB1

BITE	7	6	5	4	3	2	1	0
CLOSED			1	1	0	1		
OPENED			0	1	0	1		
CLOSED SCREEN FACE UP			1	1	1	0		
MONITOR 90° POSITION			1	0	0	1		
SCREEN ON							1	
SCREEN OFF							0	
DVI-A	0	0						
DVI 1	0	1						
DVI 2	1	1						
PROTECTION STOP								1
MONITOR OK								0

## CB2

BITE	7	6	5	4	3	2	1	0
BUTTON LOCK								1
BUTTON UNLOCK								0

# AHnet PROTOCOL

## Picture Commands

COMMAND	DESCRIPTION	RESPONSE
FA XX 15 00 00	ASK FOR BACKLIGHT LEVEL	FB XX 15 00 ZZ
FA XX 16 00 00	ASK FOR CONTRAST LEVEL	FB XX 16 00 ZZ
FA XX 17 00 00	ASK FOR BRIGHTNESS LEVEL	FB XX 17 00 ZZ

XX            Number of the monitor address.  
Up to 30 monitors for each RS422 BUS

ZZ            Level of the function selected (00 – 99 Dec)

COMMAND	DESCRIPTION	RESPONSE
FA XX 15 01 ZZ	SET BACKLIGHT LEVEL	FB XX 15 01 ZZ
FA XX 16 01 ZZ	SET CONTRAST LEVEL	FB XX 16 01 ZZ
FA XX 17 01 ZZ	SET BRIGHTNESS LEVEL	FB XX 17 01 ZZ

XX            Number of the monitor address.  
Up to 30 monitors for each RS422 BUS

ZZ            Level of the function selected (00 – 99 Dec)

To send a command to all monitors, please use the address F8.

# VIDEO SIGNALS

**AH15D3 HDGA / AH17D3 HDGA / AH19D3 HDGA / AH22D3 16GA / AH15D3 RHDGA / AH17D3 RHDGA / AH19D3 RHDGA / AH22D3 R16GA**

RESOLUTION	Horizontal freq (KHz)	Vertical freq (Hz)	Scanning type
800x600@60Hz	37.879	60.317	Progressive
800x600@72Hz	48.077	72.188	Progressive
800x600@75Hz	46.875	75.000	Progressive
1024x768@60Hz	48.363	60.005	Progressive
1024x768@70Hz	56.476	70.070	Progressive
1024x768@75Hz	60.023	75.030	Progressive
1280x720@60Hz	44.772	59.855	Progressive
1360x768@60Hz	47.720	59.799	Progressive
1280x1024@60Hz	63.981	60.020	Progressive
1600x1200@60Hz	75.000	60.000	Progressive
1680x1050@60Hz	64.742	59.946	Progressive
1920x1080@60Hz	66.647	59.980	Progressive

## AHlink

AHlink is used to control and set-up the unit.

By default, the AHlink wireless signal is deactivated. To activate it, please press and hold simulatenously the Open (1) and Close (3) buttons on the cover plate for 5 seconds. You can also activate the AHlink wireless signal by using the Interactive Setup Display (ISD) located below the monitor. Press successively the Down arrow until the AHlink appears on the LCD screen. Then, press the OK button and you will hear a 5 Beep sound. This means that the AHlink is active.

The wireless AHlink signal automatically deactivates when there is no device connected during more than 2 minutes. When the AHlink deactivates, you will hear a long Beep sound.

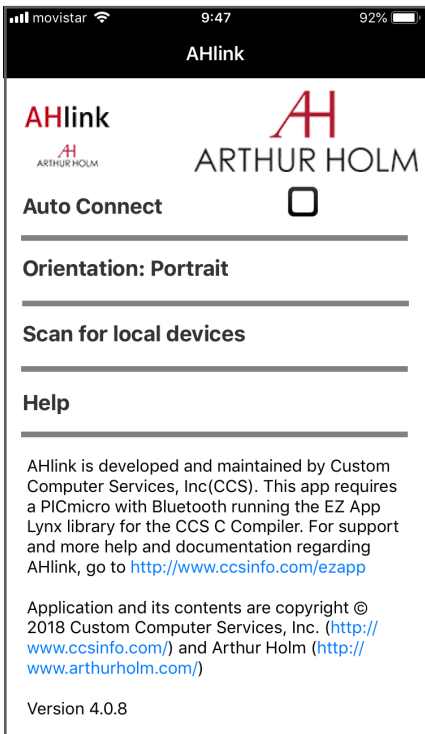

To control and set up your AH product with AHlink, please download it from the App Store (IOS system) or from Google Play (Android system) and execute it in your handled device.

It is recommended on to select *Auto Connect* and select *Portrait* on *Orientation*. To connect it, select *Scan for local devices*.

# AHLINK

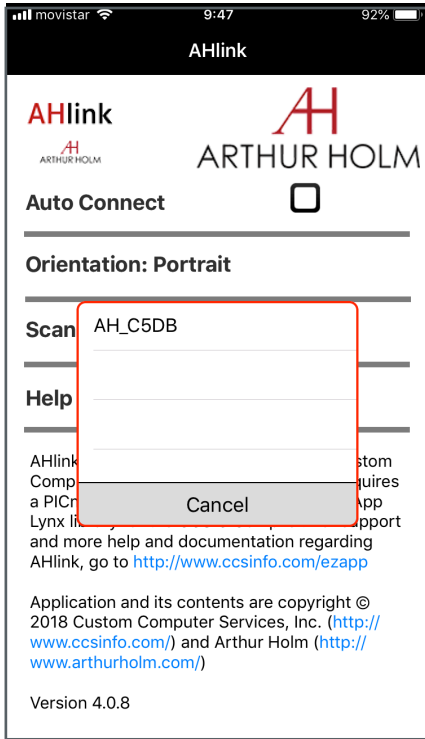

If your AH device does not appear on the screen, the AHLINK signal might no longer be active.

The AHLINK name always begins with the characters "AH" followed by the four last MAC AHLINK address. You must select the AH device.

After selecting the AH device, the first page will upload on your screen. This page is used for the basic installation setup.

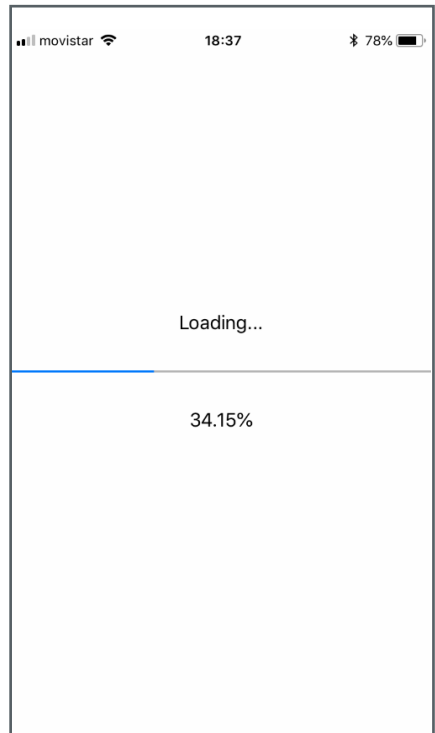

# AHlink

## D3

Dynamic3 (577FW203)

Serial: 0000000000

Ver: 1.18

**Control**

MOV OPEN CLOSE

DISP ON OFF

DVIA DVI1 DVI2

BACKL [Slider]

CONTR [Slider] 50

BRIGH [Slider] 50

SAVE VALUES AHLINK OFF

Command: 00:00:00:00:00

S1 S2 S3 S4

AHnet Address 1

Position 8

PASSWORD: 0

SERIAL

Serial number

VER

Firmware version

MOV

Open and Close screen movement's control

DISP: Turns the display ON or OFF

DVIA, DVI1, DVI2: Input selection

BACKL: Backlight adjustments

CONTR: Contrast adjustments

BRIGHT: Brightness adjustments

SAVE VALUES: Memorises the backlight, contrast and brightness values

AHLINK OFF: Turns off the AHlink signal

COMMAND: Information of the last AHnet command received from RS422 port

SENSORS: Indicates sensor status

S1 SCREEN CLOSE POSITION

S2 REAR PROTECTION COVER SENSOR ACTIVATED

AHNET ADDRESS: AH address settings

POSITION: Screen position

PASSWORD: Access to the factory's settings



# AHlink

## D3R

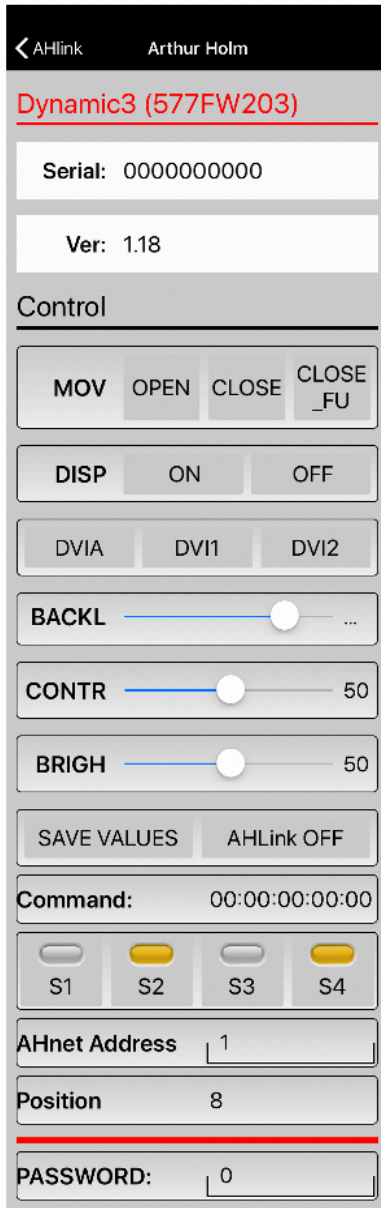

← AHlink Arthur Holm

**Dynamic3 (577FW203)**

Serial: 0000000000

Ver: 1.18

**Control**

MOV OPEN CLOSE CLOSE\_FU

DISP ON OFF

DVIA DVI1 DVI2

BACKL

CONTR 50

BRIGH 50

SAVE VALUES AHLINK OFF

Command: 00:00:00:00:00

S1 S2 S3 S4

AHnet Address 1

Position 8

PASSWORD: 0

SERIAL

Serial number

VER

Firmware version

MOV

Open and Close screen movement's control and close screen face up (rotation)

DISP: Turns the display ON or OFF

DVIA, DVI1, DVI2: Input selection

BACKL: Backlight adjustments

CONTR: Contrast adjustments

BRIGHT: Brightness adjustments

SAVE VALUES: Save settings for backlight, contrast and brightness

AHLINK OFF: Turns off the AHlink signal

COMMAND: Information about the last AHnet command received on RS422

SENSORS: Indicates sensor status

S1 SCREEN CLOSE POSITION

S2 REAR PROTECTION COVER SENSOR ACTIVATED

S3 SCREEN CLOSE ROTATE POSITION

S4 SCREEN WORKING ROTATE POSITION

AHNET ADDRESS: AH address settings

POSITION: Screen position

PASSWORD: Access to the factory's settings

## INFORMATION ON DISPOSAL FOR USERS OF WASTE ELECTRICAL & ELECTRONIC EQUIPMENT



This symbol on the products and/or accompanying documents means that used electrical and electronic products should not be mixed with general household waste.

For proper treatment, recovery and recycling, please take these products to the designated collection points, where they will be accepted on a free of charge basis. Alternatively, in some countries, you may be able to return your products to your local retailer upon the purchase of an equivalent new product.

Disposing of this product correctly will help save valuable resources and prevent any potential negative effects on human health and the environment, which could otherwise arise from inappropriate waste handling. Please contact your local authority for further details of your nearest designated collection point.

Penalties may be applicable for incorrect disposal of this waste, in accordance with national legislation.

### **For business users in the European Union**

If you wish to discard electrical and electronic equipment, please contact your dealer or supplier for further information.

### **Information on disposal in countries outside the European Union**

This symbol is only valid in the European Union. If you wish to discard this product, please contact your local authorities or dealer and ask for the correct method of disposal.

## WARRANTY TERMS AND CONDITIONS

Albiral Display Solutions warrants this product against manufacturing defects and workmanship for a period of two (2) years from the date of purchase, subject to the conditions below.

1. LCD panel, inverter, controller, electrical, electronic boards, engine, mechanical parts, accessories and power supply are warranted against manufacturing defects and workmanship for a period of two (2) years from the date of purchase.

2. LCD panels that present more than 3 defective pixels ( 15-19") and more than 4 defective pixels (20- 24") will be replaced under warranty.

3. Labour costs: Albiral Display Solutions covers the labour costs to replace any defective parts during the validity of this warranty.

4. Transport costs:

4.1 In the case that a manufacturing defect occurs within 90 days after the purchase date, both freight and insurance costs will be paid by Albiral Display Solutions.

Although Albiral Display Solutions S.L. pays for freight and insurance costs, Albiral Displays Solutions will not be responsible for any damages caused by the transportation of the goods if the customer does not inform in writing when receiving the goods.

4.2. After 90 days of the purchase date, the beneficiary of the warranty will pay both freight and insurance costs.

Albiral Display Solutions S.L. will not be responsible for any damages caused by transportation, when this one is paid by the customer.

## WARRANTY TERMS AND CONDITIONS

5. This warranty does not cover the labour costs of handling, diagnose, remove, replace, reinstall and/or program any product, force majeure causes such as vandalism or stealing.

6. This warranty does not apply if the fault has been caused by misuse, improper handling, electrical or mechanical abuse, abnormal operation conditions, non-authorized modifications, and inadequate transport or as a result of atmospheric phenomena.

7. The warranty is not valid if persons other than authorized Service Centre have handled the product and if the product has been manipulated or warranty seals are removed or manipulated.

8. The beneficiary of the warranty will have to send the devices with the original packaging to warranty there are no damages during the transport.

9. The warranty is not valid if the beneficiary of the warranty does not include RMA form and copy of the purchasing invoice.

Please note that laws vary from country to country, and the same provisions of this warranty may not apply to you.

If you have any doubts concerning the terms of this warranty, please contact:

business@albiral.com

+34 938 502 376

Copyright ©

Nov. 2020. All rights reserved

Albiral Display Solutions SL.

Registered trademarks: Albiral, Arthur Holm

**Albiral  
Display  
Solutions**

Fàtima 25, Sant Hipòlit de Voltregà  
08512 Barcelona – Spain  
tel: +34 93 850 23 76 / 23 83  
fax: +34 93 850 25 50 / 23 72  
web: [www.arthurholm.com](http://www.arthurholm.com)  
e-mail: [marketing@arthurholm.com](mailto:marketing@arthurholm.com)

**Patents**

MU17180ES00	P27178ITEP
MU17301ES00	P27178RUPC
MU17322ES00	P27178USPC
MU17413ES00	P27284DEEP
MU17445ES00	P27284EPPC
MU17854ES00	P27284ESEP
MU17868DEPC	P27284GBEP
MU17868RUPC	P27284RUPC
P24821DEEP	P27284USPC
P24821ESEP	P27715ESEP
P24821GBEP	P28089DEEP
P24821USPC	P28089ESEP
P27178DEEP	P28089ITEP
P27178EPDV01	P28089USPC
P27178EPPC	P28090EP00
P27178ESEP	P31160ESES
	P31160PCES