

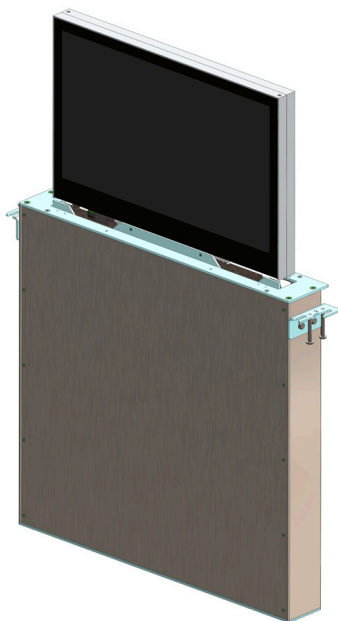

## User Guide



### DB1Twin

HDCP compliant retractable double screen monitors for furniture integration

---

Technology Serving Design

Danish craftsmanship  
Mediterranean soul

  
ARTHUR HOLM

# TABLE OF CONTENTS

REGULATIONS AND SECURITY	5
SAFETY INSTRUCTIONS	5
SYSTEM DESCRIPTION	7
INSTALLATION INSTRUCTIONS	10
CONTROLS	23
OSD MENU	24
ISD MENU	27
INPUT CONNECTORS	33
AHnet PROTOCOL	35
VIDEO SIGNALS	39
AHLink	40
INFORMATION ON DISPOSAL	43
WARRANTY TERMS AND CONDITIONS	44

## **WELCOME**

Thank you very much for purchasing an Arthur Holm product.

Please, read these installation and operating instructions carefully and keep them in a safe place for future consultations.

We remain at your entire disposal if you have any suggestions.

### **Henrik Holm**

General Manager

hholm@albiral.com

# ABOUT US

## The Company

Arthur Holm has its origins in the Danish furniture designer Jorgen Alex Jensen, who was active during the sixties and the seventies. His design inspiration and his concept of ergonomics have been continued by his family, the design force behind Arthur Holm product range. The result of combining Scandinavian design tradition with Mediterranean creativity, flexibility and emotion is a wide product range built on more than 25 years of craftsmanship.

Arthur Holm offers a professional product range where tomorrow's technology is shaped into valued materials with design flexibility and customisation, specially created to enhance communication and collaboration in reception, conference and meeting areas.

## The art of customisation

Arthur Holm offers a range of ingenious products whose designs are based on quality materials and the latest technology. Products which endow meeting and conference rooms with silent, ergonomic, innovative and aesthetic solutions that integrate into the furniture, hang from the walls as works of art or are used as interactive points of information.

## The world of Arthur Holm

Arthur Holm offers a selection of unique, elegant, versatile, flexible and ergonomic products that are being used in meeting and conference rooms, reception areas, auditoriums and public zones of leading companies throughout the world.

The numbers speak for themselves! We currently own 33 product patents, have presence in over 45 countries with products and solutions in more than 25,000 installations.

It will be our pleasure to work with you, designing your unique and personalised environment. Our broadcast electronic engineers will provide the latest technology while our design team will offer you the most exclusive appearance.

Our team puts its heart, passion and pride in all our designs.

## REGULATIONS AND SECURITY



**ATTENTION:** Do not disassemble or modify the device in any way. This symbol warns of the presence of dangerous un-insulated voltages inside some of the components, of sufficient magnitude to expose people to risk of electronic shock.



This symbol draws attention to important use and maintenance instructions in the manual that accompanies the unit.



This symbol indicates that the equipment conforms to the norms established by the European Community.



This symbol indicates D.C. current.

## SAFETY INSTRUCTIONS

### Plugs

- Do not dismantle any part of the monitor power connector.
- Disconnect the power plug from the AC outlet when the monitor is not going to be used for an indefinite period of time.

### Power and extensions cords

- Use the appropriate power cord with the correct plug type.
- Do not overload wall outlets or power cords.
- Make sure the total ampere passed through an extension cord does not exceed the maximum allowed by the cable used.
- Do not place anything on the power cord.
- Do not locate this product where a person may walk or trip over the cord.

## SAFETY INSTRUCTIONS



Wiring connected to hazardous voltage requires installation by qualified personnel or the use of ready-made flexible cables.



For your security, your equipment must be connected to an electrical outlet with grounding connection protection.

Since the plug is used to disconnect the device, the operating electrical outlet must be in an easily accessible place.

### Environment

- Install the equipment on an elevated, flat surface.
- Install the equipment in a ventilated area.
- Avoid exposing the equipment to:
  - Rain or water
  - Excessive heat, cold or humidity
  - Area exposed to direct sunlight
  - Dirty areas
  - Equipment generating strong magnetic fields
- Avoid placing open containers of liquid, near the equipment.
- Keep a minimum distance of 30 mm in order to have good ventilation.
- Never place above the device any sources of flames such as lighted candles, etc.
- If you are using the device in extreme weather conditions and/or tropical climates, the equipment should be installed in a room which ensures a reasonable level of temperature and humidity.
- To prevent damage the equipment must be firmly anchored to the surface, as shown on the installation instructions.

## SYSTEM DESCRIPTION

### General

DB1Twin is a vertically retractable monitor with double screen. Two monitors are placed back to back in a compact anodised aluminium frame displaying different contents for a 2 way communication. It is designed for reception desks, information counters or meeting and conference room tables with limited space. The screens are only visible when required, disappearing inside the table desk when not needed by simply pressing a button or by remote control.

DB1Twin has an extremely fast lift system with a very low noise level. Very easy to install, these monitors require no maintenance. To protect the user, DB1Twin are equipped with a safety system which stops the movements in case of resistance detection. They are remotely controllable and diagnosable through the ERT interfaces in an very easy and cost effective way.

### Highlights

- Double sided display
- No cover plate
- Ready for veneering (V)
- Two capacitive sensors
- Interactive Setup Display
- Maintenance free
- Energy saving design
- Wireless connectivity for setup and control
- AHlink signal to diagnose the unit

# SYSTEM DESCRIPTION

## Available Models

MODEL	DESCRIPTION
AH22DB1Twin	<p>HDCP compliant vertically retractable double Full HD 21,5" monitor to be integrated into furniture. Solid aluminium monitor housing in natural anodised finish. DVI-I and DVI-D inputs per each monitor (2). Interactive Setup Display allowing the control, setup and diagnose of the monitors. Monitors provide RS-422 I/O allowing the remote control of movements, speeds, safety settings, brightness, contrast and backlight. The monitors are equipped with AH-AMMC: an auto mechanical movement calibration system.</p>
AH22DB1TwinV	<p>HDCP compliant vertically retractable double Full HD 21,5" monitor to be integrated into furniture. Solid aluminium monitor housing in natural anodised finish. DVI-I and DVI-D inputs per each monitor (2). Interactive Setup Display allowing the control, setup and diagnose of the monitors. Monitors provide RS-422 I/O allowing the remote control of movements, speeds, safety settings, brightness, contrast and backlight. The monitors are equipped with AH-AMMC: an auto mechanical movement calibration system. Prepared for veneering. Includes a larger capacitive touch sensor on the top frame with automatic sensitive adjustment according to the veneer.</p>



# SYSTEM DESCRIPTION

## Box Contents

Before the installation of your retractable monitor, please check the contents of the shipping box, it must contain the following items:

- Monitor
- Power cord
- Remote control (1 per 5 monitors)
- Power supply 100-240Vac, 50-60Hz. Output 12V
- User guide

**Important note:** This device can only work with the power supply included in the shipping box. This power supply can not be replaced by any other rather than the original one.

## Connections

Before connecting the power:

1. Install the unit on a table or desk, in vertical position.
2. Remove the foam protecting piece before connecting the monitor.

Power connection:

1. Plug the power cable from the power supply into an AC socket of 100-240 Vac, 50-60Hz.
2. Plug the 12V D.C.  cable into the socket on the unit.



Caution! Never place this monitor in horizontal position.

## INSTALLATION INSTRUCTIONS

This symbol draws attention to important use and maintenance instructions in the manual that accompanies the unit.

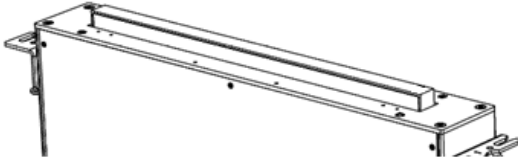

### Pattern Hole

Pattern hole dimensions for milling are specified in the corresponding drawing. The milling of the furniture has to be done from below.

### Attention

Manipulation of the product should be avoided, no stress should be applied to the product except from the instructions given in this document. Cutting, drilling, soldering, adding electrical and mechanical components can cause danger and should be avoided by all means. Not complying with these directions will result in a loss of the Arthur Holm warranty. Albiral Display Solutions S.L. shall not be liable for any loss or injury incurred as a result of modifications made to goods by anyone other than the supplier or the supplier's authorised representative with the supplier's written permission. Such modifications shall be deemed to terminate any further guarantee obligations.

# INSTALLATION INSTRUCTIONS

## Mounting table brackets

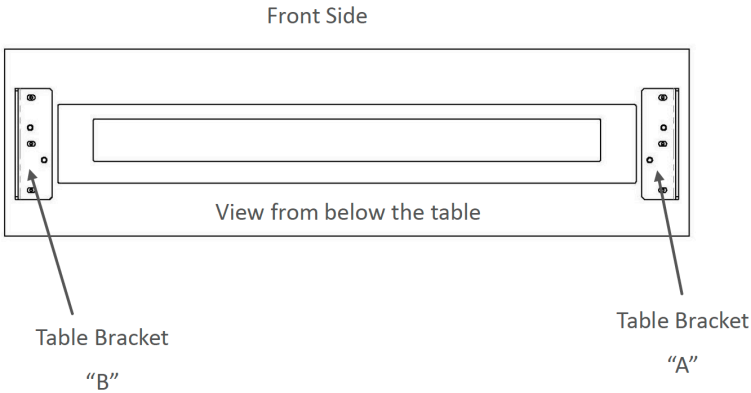
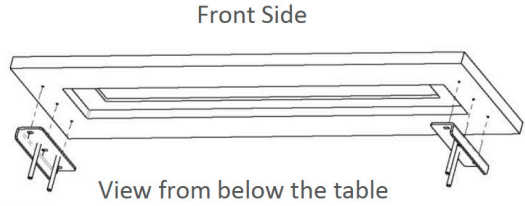

Mount the table brackets below the table using the holes indicated in the corresponding Pattern Hole drawing. The screws (x6) are not supplied. The weight of the monitor is up to 25Kg / 55.16 Lbs.

PAY ATTENTION THAT THE BRACKETS ARE MOUNTED IN THEIR CORRESPONDING SIDE.

# INSTALLATION INSTRUCTIONS

## Mounting the monitor brackets

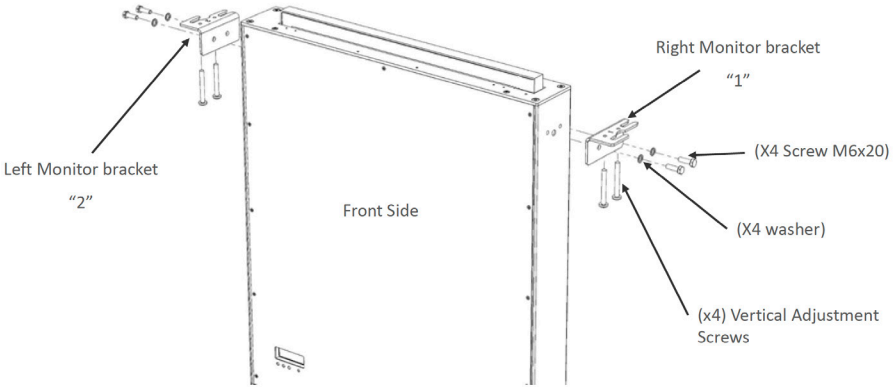

Mount the monitor brackets in their corresponding side using the supplied screws.

Mount the vertical adjustment screws (2+2) on to the monitor bracket so that the tip of the screw is flushed with the upper side of the monitor bracket.

# INSTALLATION INSTRUCTIONS

## Checking assembly

View from below the table:

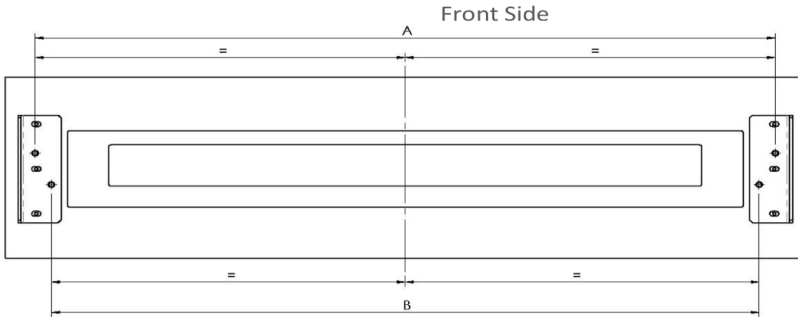

View from above the monitor:

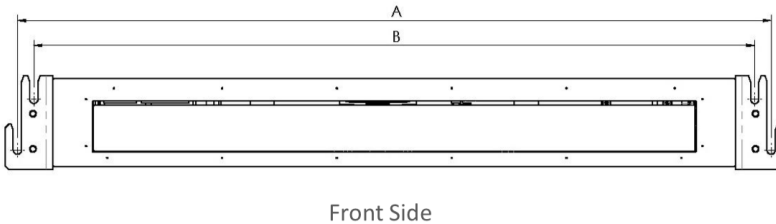

Dimensions A and B in table brackets and in monitor brackets must be the same (+-1mm).

If adjustment is necessary loosen 3+3 Table bracket screws, keeping always symmetry regarding to the monitor hole in the table. Subsequently, tighten the table bracket screws.

# INSTALLATION INSTRUCTIONS

## Hanging the monitor

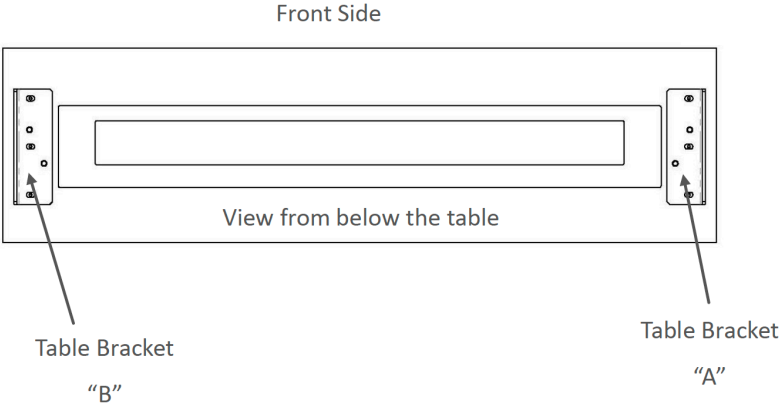

Mount 2+2 nuts on to both table brackets as indicated in the drawing.

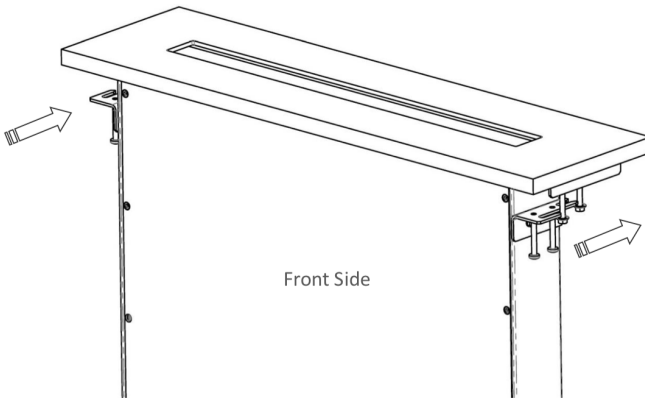

Hang the monitor above nuts.

# INSTALLATION INSTRUCTIONS

## Centring the monitor

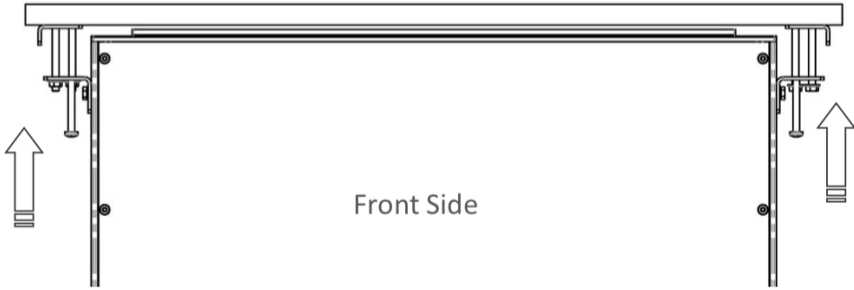

Tighten each nut gradually until the monitor surface is levelled with the table surface.

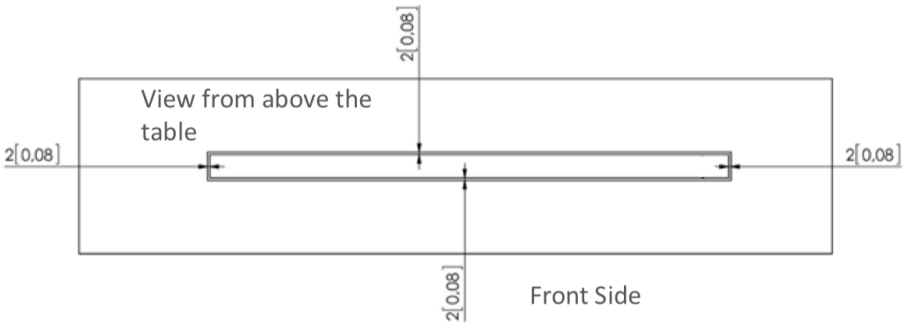

Air gap around the monitor have to be 2mm [0,08]. Otherwise the monitor could come in contact with the table while opening and be damaged.

# INSTALLATION INSTRUCTIONS

## Fine centring of the monitor

In case fine centring of the monitor is necessary:

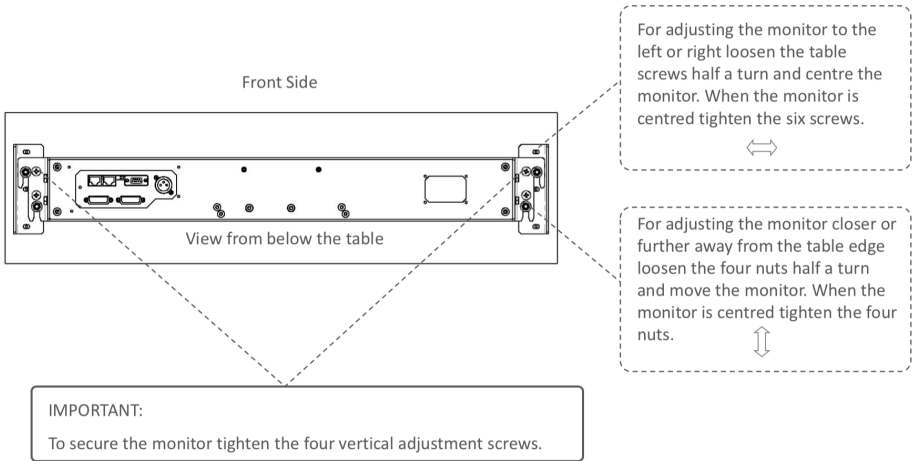



# INSTALLATION INSTRUCTIONS

## Veneer Guide

The DB1TwinV is prepared to be mounted from below the table with a Veneer finishing on the top of the monitor to match the table. The Veneer is not supplied.

The Veneer can be placed in three ways:

### Option 1:

Veneer: The veneer thickness must be 4mm [0,15] and the copper cylinder will be leveled with table surface.

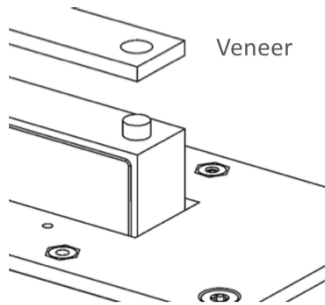

### Option 2:

Veneer + Distance Plate: For Veneers Thickness of 1mm [0,04] or less. It will be necessary a Distance Plate to hide the touch button copper cylinder.

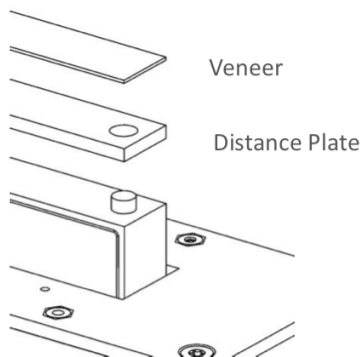

## INSTALLATION INSTRUCTIONS

### Option 3:

Veneer: The veneer thickness must be 5mm [0,16 – 0,19]. A mechanised blind hole will be necessary to hide the touch button copper cylinder.

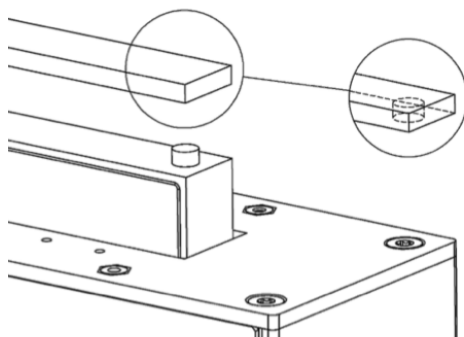



## INSTALLATION INSTRUCTIONS

### Veener Option 2:

- Distance Plate material can't be metallic. Wood or DM are advisable.
- Veneer material can't be conductor.

1. Check if the Distance Plate fits perfectly with the monitor. The copper cylinder can't project outwards from the Distance Plate surface. To make easier the adjustment the height of the copper cylinder can be barely adjusted.

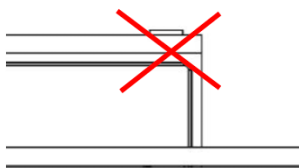

2. Clean the top surface of the metal monitor housing and the bottom surface of the Distance Plate.

3. Glue the Veneer. Double-side tape or glue can be used (depending on the kind of materials are going to be jointed). Double- side tape or glue used can't be thicker than 0,2 0,25mm [0.008 0.01]

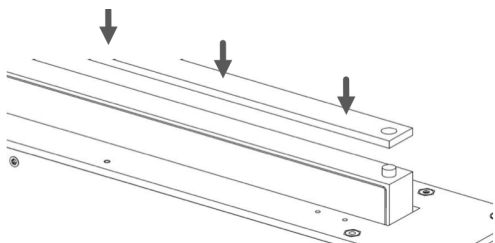

The pressure applied must not exceed 1 Kg evenly distributed on monitor surface.

# INSTALLATION INSTRUCTIONS

## Veener Option 2:

- 4. Clean the top surface of the Distance Plate and the bottom surface of the Veneer.
- 5. Glue the Veneer. Double side tape or glue can be used (depending on the kind of materials are going to be The total thickness of Veneer + glue used can't be thicker than 1mm [0.04].

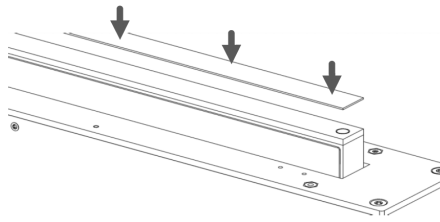

## Veener Option 2 Cut-Out:

DB1Twin Veneer cut-out:

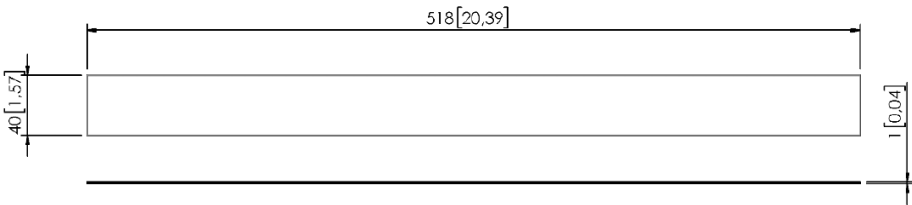

DB1Twin Distance plate cut-out:

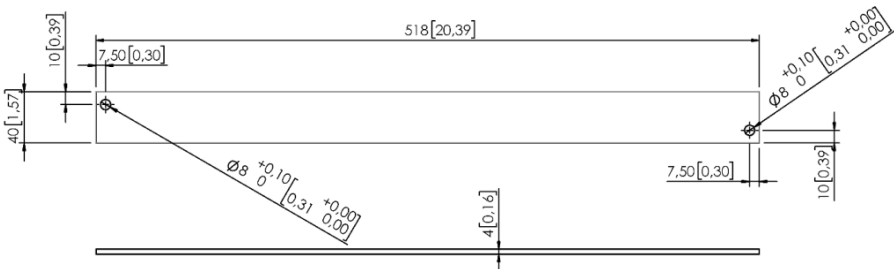

# INSTALLATION INSTRUCTIONS

## Veener Option 3:

- Veneer material can't be conductor.

1. Check if the Veneer fits perfectly with the monitor. To join both parts correctly it is important that the two surfaces are touching each other in the whole length. If there is a gap between the Veneer and the monitor, check if the hole depth in the Veneer is correct. (To make easier the adjustment the height of the copper cylinder can be barely adjusted.)

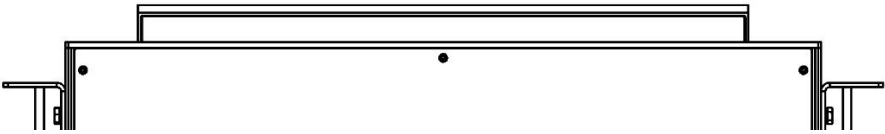

2. Clean the top surface of the metal monitor housing and the bottom surface of the Veneer.

3. Glue the Veneer. Double side tape or glue can be used (depending on the kind of materials are going to be jointed). Double side tape or glue used can't be thicker than 0,2 - 0,25mm [0.008 0.01]

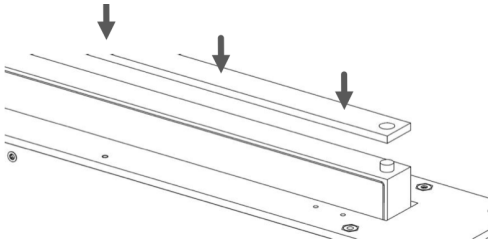

The pressure applied must not exceed 1 Kg evenly distributed on monitor surface.

## Veener Option 3 Cut-Out:

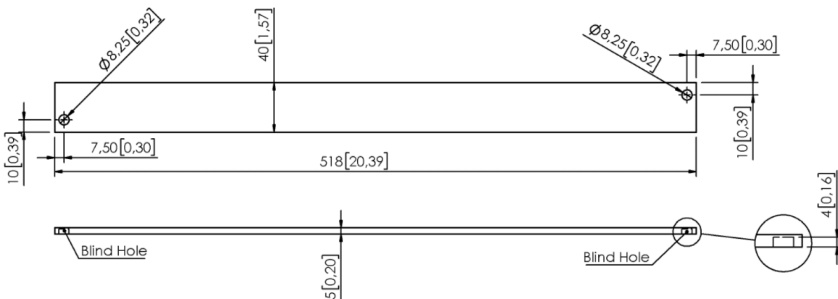

# CONTROLS

## IR sensor

The IR sensor is located on the lower side of the screen.

## Monitor movement controls

On the monitor's top, there are two sensors to control the up and down monitor movements.



- Open / Close sensor:

Touch any of the 2 sensors located on the top of the monitor to control the Up and Down movements. Make sure that no objects are placed on top of the monitor.

## Remote control

POWER	Switch ON/OFF the monitor
MENU	Activates the OSD menu on screen
UP	Control up on the OSD menu
DOWN	Control down on the OSD menu
LEFT	Control left on the OSD menu
RIGHT	Control right on the OSD menu
OK	Selects the function on the OSD menu. When the OSD menu is not active on screen, selects the input source

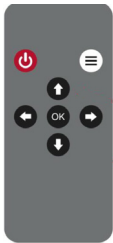

## OSD MENU

### Accessing the menu system

- With the OSD off, push the MENU button to activate the main OSD menu.
- Press the UP and DOWN buttons to move from one function to another. Please refer to the following sections below to view a complete list of all the functions available for the monitor.
- Press the OK button to confirm.
- When a function is selected, press the LEFT and RIGHT buttons in order to change the parameter of the function.

Press the MENU button to access to the main menu.

### Picture

Picture Mode: Adjusts the mode of the image

- Dynamic
- Standard
- Mild
- User: Contrast - Brightness - Colour - Sharpness - Tint

Colour Temperature: Adjusts the colour of the image

- Cool
- Medium
- Warm
- Use: Red - Green - Blue

Aspect Ratio: Adjusts the image aspect on screen

- 4:3
- 16:9
- Just scan



## OSD MENU

Noise Reduction: Adjusts the image noise filter

- Off
- Low
- Medium
- High
- Default

Screen: (Only for analogue signals)

- Auto Adjust
- Horizontal Position
- Vertical Position
- Size
- Phase

Backlight: Adjusts the backlight screen's level

Colour Range: Adjusts the colour range

- 0 - 255
- 16 - 235

## OSD MENU

### Option

Language: OSD language selection

Restore Factory Default: Adjusts the parameters to the initial factory parameters

Blending: OSD window transparency

- Low
- Medium
- High
- Off

OSD Duration: Adjusts the time that the OSD menu window remains on the screen

Software Update (USB): Port to use for firmware's upgrade.

Mirror:

0. Image with no flip
1. Vertical flip
2. Horizontal flip
3. Rotate

## ISD MENU

The Interactive Setup Display is an LCD screen located at the monitor casing inside the desk that allows the setup and provides useful diagnose and historical data of the device.

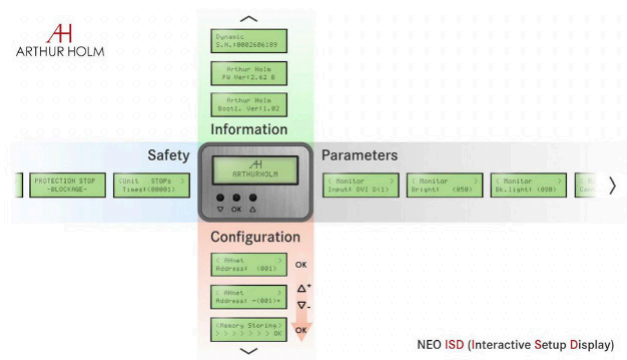

- To start using it -

### • WELCOME DISPLAY & DATA :

#### 1) Bootloader Version

The display will show a Bootloader Version message (example: Bootl. Ver: 1.01). Bootloader is a program which allows the system to be able to update itself. The ISD has a Bootloader and therefore is capable of updating to new versions in order to constantly improve the user experience.

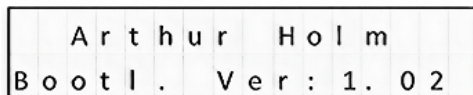



## ISD MENU

### · MENUS GENERAL INFORMATION

#### 1) AHnet - Adress

The address must be set from 1 to 60.

```
<  A H n e t      >  
A d d r e s s :   ( 0 0 1 )
```

#### 2) VIDEO INPUT SELECTION

The device provides the following inputs:

DVI1 = DVI-I (DVI-A and DVI-I-D)

DVI2= DVI-D (DVI-2D)

This menu allows the selection of 1 of these 3 inputs.

```
<  M o n i t o r  >  
I n p u t :   D V I _ D ( 1 )
```

#### 3) MONITOR BRIGHTNESS

Brightness level (0 – 100).

```
<  M o n i t o r  >  
B r i g h t :   ( 0 5 0 )
```

#### 4) MONITOR CONTRAST

Contrast level (0 – 100).

```
<  M o n i t o r  >  
C o n t r a s t :   ( 0 5 0 )
```

## ISD MENU

### 5) MONITOR BACKLIGHT

Backlight level (0 – 100).

```
< M o n i t o r >
B k . l i g h t : ( 0 5 0 )
```

### 6) POSITION

It is a diagnostic option that informs about the position of the device.

```
< M o n i t o r >
P o s i t i o n : ( 0 2 3 )
```

### 7) SENSORS INFORMATION

It is a diagnostic option that informs about the internal state of the sensors.

```
S 1 | 2 | 3 | 4 | 5 | 6 | 7 | 8
I 0 | 1 | 1 | 1 | 1 | 1 | 1 | 1
```

### 8) AHnet - INFORMATION

This menu is useful for programming and diagnose.

It provides information about the AHnet command that has been received by the device.

Example: AHnet = 0 (FA) 1 (01) 2 (01) 3 (01) 4 (00)

```
A H n e t : 0 ( F A ) 1 ( 0 1 )
2 ( 0 1 ) 3 ( 0 1 ) 4 ( 0 0 )
```

## ISD MENU

### 9) UNIT OPENS

It is a diagnostic option that provides historical data.

It is very useful to analyze how the device has been used during its lifecycle and it provides information about how many movements the device has done.

```
< U n i t   O p e n i n g s   >  
T i m e s : ( 0 0 0 0 0 )
```

### 10) UNIT STOPS

It is a diagnostic option that provides historical data. It is very useful to analyze how the device has been used during its lifecycle.

It provides information about the number of times that the device has been protected and made emergency stops.

```
< U n i t   S T O P S   >  
T i m e s : ( 0 0 0 0 0 )
```

### 11) SERIAL NUMBER

Provides the device's serial number.

```
< S e r i a l   N u m b e r   >  
S . N . : 0 1 2 3 4 5 6 7 8 9
```

The serial number can also be obtained via AHnet and AHlink.

### 12) MONITOR DOWN

Only use this function as per manufacturer advice.

```
< M o n i t o r   D O W N   >  
O n l y   f o r   S E R V I C E
```

## ISD MENU

### 13) AUTO ADJUST

Auto Mechanical Movement Calibration (AH-AMMC).

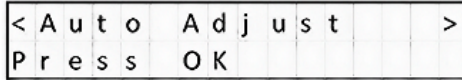

Protocol activation: the device will make a consecutive movements series that must not be interrupted. The system will calibrate the speed and protection thresholds.

### 14) AHLINK

Activates AHLINK.

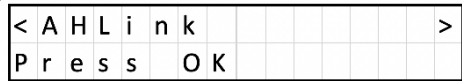

## FIRMWARE UPDATE

To update the FW version.

To start the update, connect a PC with the APP AH\_FW (Device Setting Tool) to the device through the USB port.

Proceed with the following steps:

- Unplug the PSU
- Wait for 1 minute
- Press and hold the "OK" button
- Plug in the PSU
- A message will appear on the LCD screen when the connection is ready
- Start updating the AH\_FW

**How are you doing? Easy, right?**

Now you just have to start enjoying your device 😊



# INPUT CONNECTORS

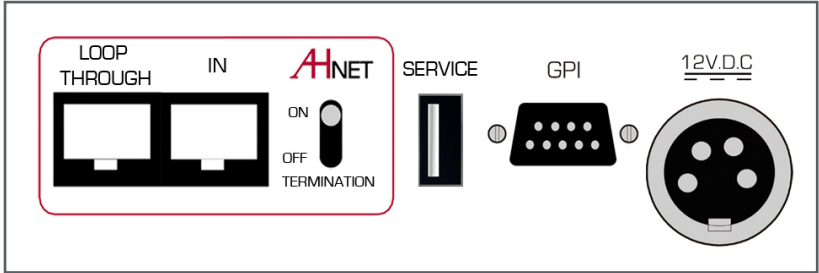

**12V D.C.**  : Power supply input connector. XLR-4 connector.

- 1,2: Ground
- 3,4: 12Vdc

**GPI:** Monitor external contact close control. SubD9 female.

1. GPI1 +
2. GPI1 -
3. GPI2 +
4. GPI2 -
5. GPI3 -
6. GPI3 +
7. N.C.

8. +12Vdc (600mA max.)

9. Ground:

- Use GPI1 (1:12Vdc, 2: Ground) to open the monitor
- Use GPI3 (6:12Vdc, 5: Ground) to close he monitor

**Termination:** Activate (ON) the termination. Only on the last unit of the RS422 bus.

**AHnet:** RJ45 CAT6 connector for addressable RS422 control. There is a loop through connector to use as signal RS422 output. Up to 30 monitors can be connected on the same RS422 bus.

**Service:** Used for firmware's upgrade.

## INPUT CONNECTORS

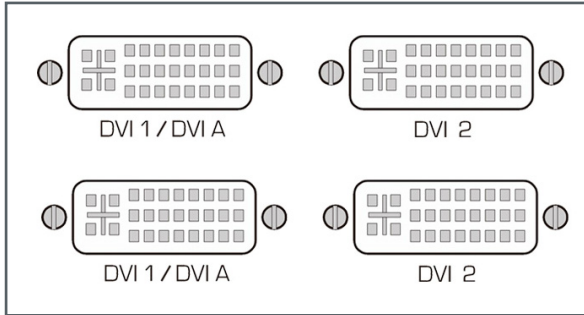

**DVI 1 / DVI A:** DVI-I input signal. Connect a DVI (digital) input signal and select DVI 1 on the OSD monitor menu. Use a DVI to VGA adaptor to connect an ARGB (analogue) input signal and select DVI-A on the OSD monitor menu.

**DVI 2:** DVI-D input signal. Connect a DVI (digital) input signal and select DVI 2 on the OSD monitor menu.

- Use high quality DVI cables with 2m maximum length.



On RS422 connectors, connect only RS422 signals. Be careful not to connect Network cables or PoE signals. It will seriously damage the monitor.

# AHnet PROTOCOL

## Communications protocol

COMMUNICATION	RS422
CONNECTION	RJ45
WIRING	CAT-6

## Speed and configuration

BAUD RATE	38400
DATA BITS	8
PARITY	NONE
STOP BITS	1

## Wiring Diagram

- 1. Data TX +
- 2. Data TX -
- 3. Data RX +
- 4. NC
- 5. NC
- 6. Data RX -
- 7. NC
- 8. NC



RJ-45

## Connection

PINS 1 & 2	The units respond
PINS 3 & 6	The units receive instructions

Protocol to control the monitor by addressable RS422 bus.  
You can connect up to 30 monitors on the same RS422 bus.  
You can use an AH ERT interface, to control the RS422 bus.  
The units should have a set address and the address must start by 1.  
Maximum cable length between ends: 500 m/1 640 ft.

# AHnet PROTOCOL

## AHnet protocol

Uses 5 bytes communication:

<b>BYTE 0</b>	START BYTE
<b>BYTE 1</b>	ADDRESS BYTE
<b>BYTE 2</b>	COMMAND BYTE
<b>BYTE 3</b>	VALUE 1
<b>BYTE 4</b>	VALUE 2

## Commands

COMMAND	DESCRIPTION	RESPONSE
FA XX 01 01 00	GO UP	FB XX 01 01 00
FA XX 01 00 00	GO DOWN	FB XX 01 00 00
FA XX 02 01 00	SCREEN ON	FB XX 02 01 00
FA XX 02 00 00	SCREEN OFF	FB XX 02 00 00
FA XX 03 01 00	DVI-A SELECTION	FB XX 03 01 00
FA XX 03 00 00	DVI-1 SELECTION	FB XX 03 00 00
FA XX 03 03 00	DVI-2 SELECTION	FB XX 03 03 00
FA XX 04 01 00	BUTTON LOCK	FB XX 04 01 00
FA XX 04 00 00	BUTTON UNLOCK	FB XX 04 00 00
FA XX 14 00 00	INQUIRY CONTROL BYTE	FB XX 14 CB1 CB2

XX      Number of the monitor address. Up to 30 monitors for each RS422 BUS

CB1     Response in 8 bites of the monitor status

CB2     Response in 8 bites of the monitor status

# AHnet PROTOCOL

## CB1

BITE	7	6	5	4	3	2	1	0
CLOSED			1	1	0	1		
OPENED			0	1	0	1		
SCREEN ON							1	
SCREEN OFF							0	
DVI-A	0	0						
DVI 1-D	1	1						
DVI 2-D	1	0						
PROTECTION STOP								1
MONITOR OK								0

## CB2

BITE	7	6	5	4	3	2	1	0
BUTTON LOCK								1
BUTTON UNLOCK								0

# AHnet PROTOCOL

## Picture Commands

COMMAND	DESCRIPTION	RESPONSE
FA XX 15 00 00	ASK FOR BACKLIGHT LEVEL	FB XX 15 00 ZZ
FA XX 16 00 00	ASK FOR CONTRAST LEVEL	FB XX 16 00 ZZ
FA XX 17 00 00	ASK FOR BRIGHTNESS LEVEL	FB XX 17 00 ZZ

XX            Number of the monitor address.  
Up to 30 monitors for each RS422 BUS

ZZ            Level of the function selected (00 – 99 Dec)

COMMAND	DESCRIPTION	RESPONSE
FA XX 15 01 ZZ	SET BACKLIGHT LEVEL	FB XX 15 01 ZZ
FA XX 16 01 ZZ	SET CONTRAST LEVEL	FB XX 16 01 ZZ
FA XX 17 01 ZZ	SET BRIGHTNESS LEVEL	FB XX 17 01 ZZ

XX            Number of the monitor address.  
Up to 30 monitors for each RS422 BUS

ZZ            Level of the function selected (00 – 99 Dec)

To send an order to all the monitors, you must use the address:  
249 Dec. (Byte1)  
F9 Hex. (Byte1)

In this case, the units do not send a reply.

# VIDEO SIGNALS

RESOLUTION	Horizontal freq (KHz)	Vertical freq (Hz)	Scanning type
800x600@60Hz	37.879	60.317	Progressive
800x600@72Hz	48.077	72.188	Progressive
800x600@75Hz	46.875	75.000	Progressive
1024x768@60Hz	48.363	60.005	Progressive
1024x768@70Hz	56.476	70.070	Progressive
1024x768@75Hz	60.023	75.030	Progressive
1280x720@60Hz	44.697	59.915	Progressive
1280x768@60Hz	47.396	59.995	Progressive
1360x768@60Hz	47.720	59.799	Progressive
1280x1024@60Hz	63.981	60.020	Progressive
1680x1050@60Hz	65.160	59.944	Progressive
1600x1200@60Hz	74.479	59.967	Progressive
1920x1080@60Hz	67.500	60.000	Progressive

# AHlink

AHlink is used to control and set-up the unit.

By default, the AHlink wireless signal is deactivated. To activate it, please press and hold the Open/Close sensors simultaneously on the top of the monitor for 5 seconds.

You can also activate the AHlink signal with the LCD (Interactive Setup Display) located under the monitor. Press the Down key near the LCD (Interactive Setup Display), until the "<AHlink>" option appears. Press the OK button to activate the AHlink signal on the unit. When the AHlink signal is activated, the sound of 5 beeps will indicate that the AHlink signal is active on the unit.

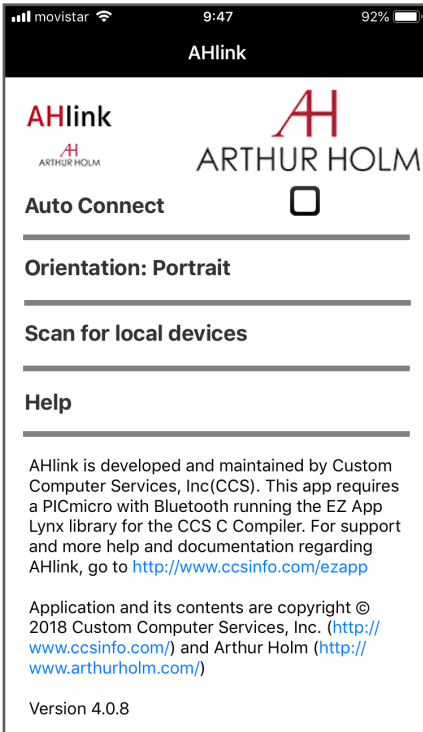

The wireless AHlink signal automatically deactivates when there is no device connected during more than 2 minutes. When the AHlink deactivates, you will hear a long Beep sound.

To control and set up your AH product with AHlink, please download it from the App Store (IOS system) or from Google Play (Android system) and execute it in your handled device.

It is recommended on to select *Auto Connect* and select *Portrait* on *Orientation*. To connect it, select *Scan for local devices*.



# AHlink

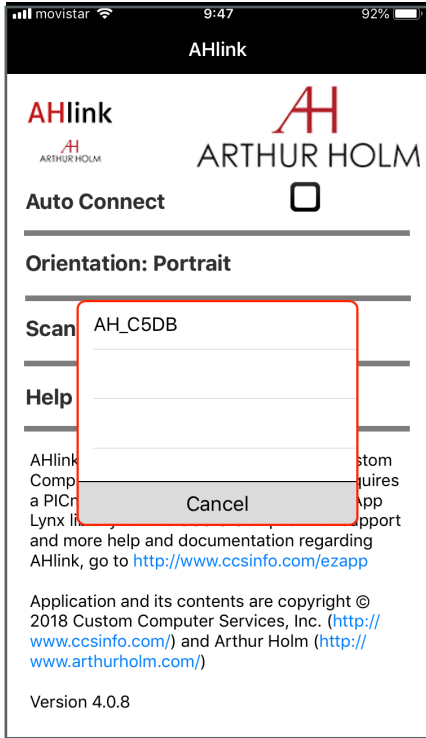

After selecting the AH device, the first page will upload on your screen. This page is used for the basic installation setup.

If your AH device does not appear on the screen, the AHLink signal might no longer be active.

The AHLink name always begins with the characters "AH" followed by the four last MAC AHLink address. You must select the AH device.

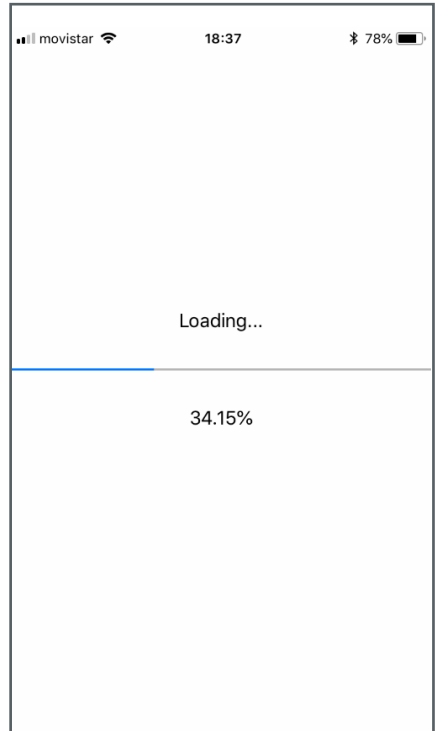

# AHlink

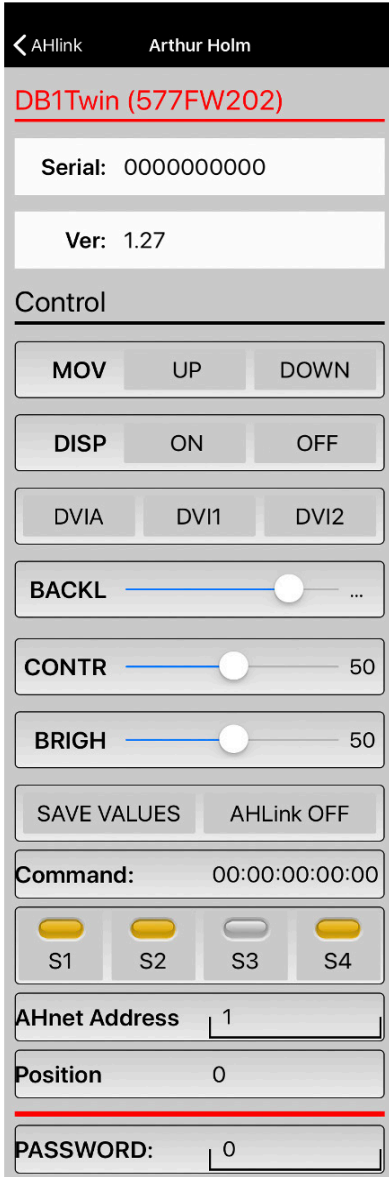

## SERIAL

Serial number of the unit

## VER

Firmware version

## MOV

Controls the Up and Down monitor movements

DISP: Turns the display ON or OFF

DVIA, DVI1, DVI2: Input source selection

BACKL: Backlight adjustments

CONTR: Contrast adjustments

BRIGHT: Brightness adjustments

SAVE VALUES: Memorises the backlight, contrast and brightness values

AHLINK OFF: Turns off the AHlink signal

COMMAND: Information of the last AHnet command received from RS422 port

SENSORS: Indicates sensor status.

S1 OPEN POSITION

AHNET ADDRESS: AH address settings

POSITION: Screen position

PASSWORD: Access to the factory's settings

## INFORMATION ON DISPOSAL FOR USERS OF WASTE ELECTRICAL & ELECTRONIC EQUIPMENT



This symbol on the products and/or accompanying documents means that used electrical and electronic products should not be mixed with general household waste.

For proper treatment, recovery and recycling, please take these products to the designated collection points, where they will be accepted on a free of charge basis. Alternatively, in some countries, you may be able to return your products to your local retailer upon the purchase of an equivalent new product.

Disposing of this product correctly will help save valuable resources and prevent any potential negative effects on human health and the environment, which could otherwise arise from inappropriate waste handling. Please contact your local authority for further details of your nearest designated collection point.

Penalties may be applicable for incorrect disposal of this waste, in accordance with national legislation.

### **For business users in the European Union**

If you wish to discard electrical and electronic equipment, please contact your dealer or supplier for further information.

### **Information on disposal in countries outside the European Union**

This symbol is only valid in the European Union. If you wish to discard this product, please contact your local authorities or dealer and ask for the correct method of disposal.

## WARRANTY TERMS AND CONDITIONS

Albiral Display Solutions warrants this product against manufacturing defects and workmanship for a period of five (5) years from the date of purchase, subject to the conditions below.

1. Mechanical parts: The engine and the product's mechanical parts are warranted against manufacturing defects and workmanship for a period of five (5) years from the date of purchase.
2. LCD panel, inverter, controller, electrical, electronic boards, accessories and power supply are warranted against manufacturing defects and workmanship for a period of two (2) years from the date of purchase.
3. LCD panels that present more than 3 defective pixels (15-19") and more than 4 defective pixels (20-24") will be replaced under warranty.
4. Labour costs: Albiral Display Solutions covers the labour costs to replace any defective parts during the validity of this warranty.
5. Transport costs:
  - 5.1. In the case that a manufacturing defect occurs within 90 days after the purchase date, both freight and insurance costs will be paid by Albiral Display Solutions.

Although Albiral Display Solutions S.L. pays for freight and insurance costs, Albiral Displays Solutions will not be responsible for any damages caused by the transportation of the goods if the customer does not inform in writing when receiving the goods.

- 5.2. After 90 days of the purchase date, the beneficiary of the warranty will pay both freight and insurance costs.

Albiral Display Solutions S.L. will not be responsible for any damages caused by transportation, when this one is paid by the customer.

6. This warranty does not cover the labour costs of handling, diagnose, removal, replacement, reinstall and/or program any product.

## WARRANTY TERMS AND CONDITIONS

7. This warranty does not apply if the fault has been caused by misuse, improper handling, electrical or mechanical abuse, abnormal operation conditions, non-authorized modifications, and inadequate transportation or as a result of atmospheric phenomena.
8. The warranty is not valid if people other than authorized Service Centre have handled the product and if the product has been manipulated or warranty seals are removed or manipulated.
9. The beneficiary of the warranty will have to return the product with the original packaging to warranty there are no damages during transportation.
10. The warranty is not valid if the beneficiary of the warranty does not include an RMA form and a copy of the purchasing invoice.

Please note that laws vary from country to country, and the same provisions of this warranty may not apply to you.

If you have any doubts concerning the terms of this warranty, please contact:

[business@albiral.com](mailto:business@albiral.com)

+34 938 502 376

Copyright ©

Nov. 2020. All rights reserved

Albiral Display Solutions SL.

Registered trademarks: Albiral, Arthur Holm



ARTHUR HOLM

**Albiral  
Display  
Solutions**

Fàtima 25, Sant Hipòlit de Voltregà  
08512 Barcelona – Spain  
tel: +34 93 850 23 76 / 23 83  
fax: +34 93 850 25 50 / 23 72  
web: [www.arthurholm.com](http://www.arthurholm.com)  
e-mail: [marketing@arthurholm.com](mailto:marketing@arthurholm.com)

### Patents

MU17180ES00	P27178RUPC
MU17301ES00	P27178USPC
MU17322ES00	P27284DEEP
MU17413ES00	P27284EPPC
MU17445ES00	P27284ESEP
MU17854ES00	P27284GBEP
MU17868DEPC	P27284RUPC
MU17868RUPC	P27284USPC
P24821DEEP	P27715ESEP
P24821ESEP	P28089DEEP
P24821GBEP	P28089ESEP
P24821USPC	P28089ITEP
P27178DEEP	P28089USPC
P27178EPDV01	P28090EP00
P27178EPPC	P31160ESES
P27178ESEP	P31160PCES