



User manual



AH15D3 HDGA
AH17D3 HDGA

AH19D3 HDGA
AH22D3 16GA

Electrically motorised monitor for furniture integration.
Vertical working position

ARTHUR HOLM

Table of contents

EC REGULATIONS & SECURITY	4
SAFETY INSTRUCTIONS	5
APPLICATIONS	6
FEATURES	6
BOX CONTENTS	6
PREPARATION FOR INSTALLATION	7
CONTROLS & INPUT CONNECTORS	9
OSD MENU	13
AHnet PROTOCOL	16
INPUT SIGNALS	20
PRODUCT WARRANTY	23

Welcome

Thank you for purchasing an ARTHUR HOLM product.

Our product range has been designed to create the perfect meeting room, where the screens are a part of the interior design as well as essential communication tools.

Please, read this installation and operating instructions carefully and keep them in a safe place for future reference.

We remain at your entire disposal if you have any suggestions that would help us improve our products.

Henrik Holm
General Manager

EC Regulations and Security



ATTENTION: Do not disassemble or modify the device in any way.

This symbol warns of the presence of dangerous un-insulated voltages inside some of the components, of sufficient magnitude to expose people to risk of electronic shock.



This symbol draws attention to important use and maintenance instructions in the manual that accompanies the unit.



This symbol indicates that the equipment conforms to the norms established by the European Community.



This symbol indicates that the equipment has some potential entrapment hazard parts.

Safety instructions

PLUGS

- Do not dismantle any part of the monitor power connector
- Disconnect the power plug from the AC outlet when the monitor is not going to be used for an indefinite period of time

POWER AND EXTENSIONS CORDS

- Use the appropriate power cord with the correct plug type
- Do not overload wall outlets or power cords
- Make sure the total ampere passed through a extension cord does not exceed the maximum allowed by the cable used
- Do not place anything on the power cord
- Do not locate this product where a person may walk or trip over the cord



Wiring connected to hazardous voltage requires installation by qualified personnel or the use of ready-made flexible cables.

For your security, your equipment must be connected to an electrical outlet with grounding connection protection.

The operating electrical outlet must be in an easily accessed place.

ENVIRONMENT

- Install the equipment on an elevated, flat surface
- Install the equipment in a ventilated area
- Avoid exposing the equipment to:
 - Rain or water
 - Excessive heat, cold or humidity
 - Areas exposed to direct sunlight
 - Dirty areas
 - Equipment generating strong magnetic fields
- Avoid placing open containers of liquid, near the equipment
- Keep a minimum distance of 30mm in order to have good ventilation
- Never place any sources of flames, such as lighted candles, etc. above the device
- If you are using the device in extreme weather conditions and/or tropical climates, the equipment should be installed in a room which ensures a reasonable level of temperature and humidity
- To prevent damage the equipment must be firmly anchored to the surface, as shown in the installation instructions
- When the monitor is closed, the maximum static load is 15Kg /33 lbs

System Description

APPLICATIONS

The Dynamic3 system is a professional TFT display with an elegant housing and an electrical system for installation into a horizontal furniture surface. The mechanism offers a vertical working position. With the push of a button, the monitor is lifted to be used vertically.

FEATURES

- TFT Active Matrix display
 - AH15D3 HDGA 15.6", widescreen format, FULL HD
 - AH17D3 HDGA 17.3", widescreen format, FULL HD
 - AH19D3 HDGA 18.5", widescreen format, FULL HD
 - AH22D3 16GA 21.5", widescreen format, FULL HD
- Motorised monitor with electrical engine for furniture integration
- Vertical working position
- Up/Down function operated by buttons on the cover plate
- Low power consumption
- Low radiation
- Quick response time
- Data inputs DVI-I & DVI-D. HDCP compliant
- Addressable RS422 monitor control by AHnet protocol, RJ45 connector CAT5

BOX CONTENTS

Before the installation of your motorised monitor, please check the contents of the shipping box, it must contain the following items:

- *Monitor unit*
- *Power cord*
- *Monitor power supply 100-240Vac, 50-60Hz. Output 12V*
- *Remote control*
- *User Manual*

Preparation for Installation

Before the installation of the device, please make sure to follow these steps:

- Remove the two lateral transport plastic screws M8x30

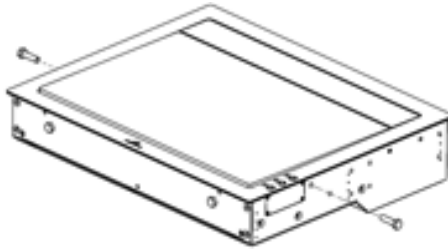

- Remove the two front transport plastic screws M8x30

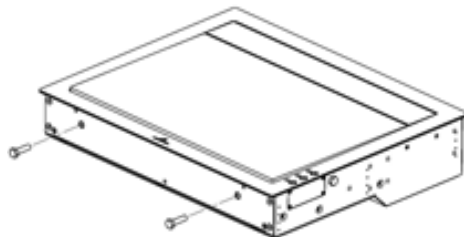

Preparation for Installation

Follow the next steps to pack the device for a safe shipment:

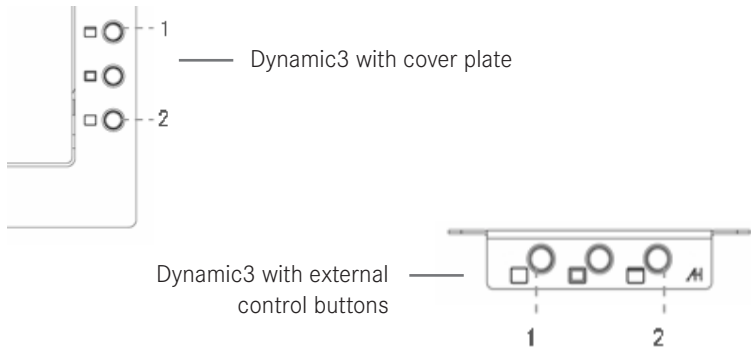

Permanent press button 1 until the monitor housing gets released from the frame. Insert the two plastic screws (M8x30) entirely. To close the monitor, permanent press button 2 until the monitor housing touches the two plastic screws.

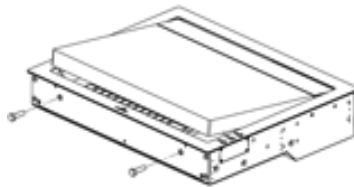

The next step is to insert the two lateral plastic screws (M8x30). Starting by the right hand side, turn the plastic screw into the frame until it touches the aluminium housing; without moving the aluminium housing (very fine tolerances). Next, insert the plastic screw into the left side by turning it until it touches the aluminium housing.

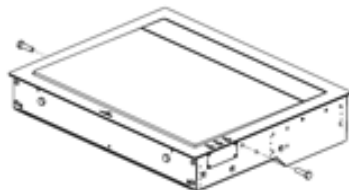

Controls & Input connectors

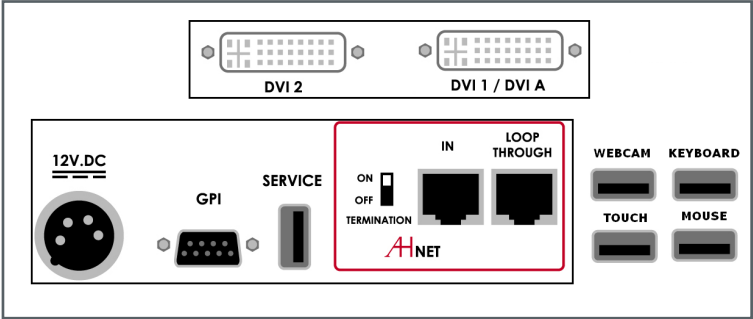

- DVI 1 / DVI A DVI-I input signal. Connect a DVI (digital) input signal and select DVI 1 on the OSD monitor menu. Use a DVI to VGA adapter to connect an ARGB (analogue) input signal and select DVI-A on the OSD monitor menu

- DVI 2 DVI-D input signal. Connect a DVI (digital) input signal and select DVI 2 on the OSD monitor menu
 - Use high quality DVI cables with 2m maximum length

- 12V D.C. Power supply input connector. XLR-4 connector:
 1,2: Ground
 3,4: 12Vdc

- GPI Monitor external contact close control. SubD9 female
 1. GPI1 +
 2. GPI1 -
 3. GPI2 +
 4. GPI2 -
 5. GPI3 -
 6. GPI3 +
 7. N.C.
 8. +12Vdc (600mA max.)
 9. Ground
 - Use GPI1 (1:12Vdc, 2:Ground) to open the monitor
 - Use GPI2 (3:12Vdc, 4:Ground) to close the monitor with the screen facing up
 - Use GPI3 (6:12Vdc, 5:Ground) to close the monitor with the screen facing down

Controls & Input connectors

Termination	Activate (ON) the termination, ONLY on the last unit of the RS422 bus
AHnet	RJ45 CAT5 connector for addressable RS422 control. There is a loop through connector to use as signal RS422 output. Up to 30 monitors can be connected on the same RS422 bus
USB	USB connectors for mouse, keyboard, touch screen and webcam. These connectors are active depending on the monitor model

OSD MONITOR CONTROL

In order to access to the OSD monitor control menu, use the IR remote control supplied with the monitor

POWER	Switch ON/OFF the monitor
MENU	Activates the OSD menu on screen
UP	Cursor control up on the OSD menu
DOWN	Cursor control down on the OSD menu
LEFT	Cursor control left on the OSD menu
RIGHT	Cursor control right on the OSD menu
OK	Selects the function on the OSD menu. When the OSD menu is not active on screen, selects the input source

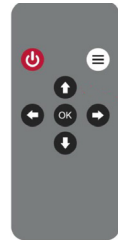

Controls & Input connectors

MONITOR ADDRESS

Below the monitor, there is a screen to configure the monitor. Press the UP or DOWN buttons to change the function. Press the OK button to select the function. Change the parameter using the UP or DOWN buttons and press OK again to save the changes.



- AHnet ID Selects the number AHnet ID to RS422 to externally control the monitor
- Input select Selects the input source signal (DVIA, DVI1 or DVI2)
- Brightness Configuration of the monitor brightness level
- Contrast Configuration of the monitor contrast level
- Backlight Configuration of the monitor backlight level
- Status information List of the monitor status to service

Controls & Input connectors

MONITOR MOVEMENT CONTROLS

On the upper cover plate, there are three buttons to control the monitor's up and down functions:

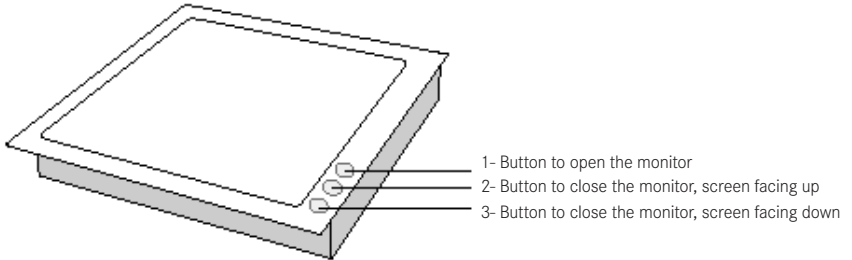

1. Raising the monitor

To rise up and tilt the monitor display, press the rear button (1) on the right hand side of the cover plate. To adjust the angle, permanent press the open button (1). While the monitor is open; the screen will slowly move between 90° to 110°. When the screen is on the desired working angle, release the button (1). To memorise this working angle permanently, press the middle button (2) during 2 seconds.

2. Memory button:

Permanent press this button to memorise the screen tilting angle.

3. Retracting the monitor (downwards the screen)

To fold down the monitor with the screen facing down, going into storage position, press the front button (3). It is recommended that no objects or parts of the body that could obstruct the retracting movement of the display, are not on the top of the cover plate.

OSD menu

ACCESSING THE MENU SYSTEM

- With the OSD off, push the MENU button to activate the main OSD menu
- Press the UP and DOWN button to move from one function to another.
Please refer to the following sections below to view a complete list of all the functions available for the monitor
- Press the OK button to enable the item
- When a function is selected, press the LEFT and RIGHT buttons in order to change the parameter of the function

Press the Menu button to access to the main menu

PICTURE

Picture Mode Adjusts the mode of the image

Dynamic
Standard
Mild

User: Contrast, Brightness, Colour, Sharpness, Tint

Colour Temperature Adjusts the color of the image

Cool
Medium
Warm

User: Red, Green, Blue

Aspect Ratio Configures the image aspect on screen

4:3
16:9
Just scan

OSD menu

PICTURE

Noise Reduction Adjusts the image noise filter

Off
Low
Middle
High
Default

Screen (Only for analogue signals)

Auto Adjust
Horizontal Pos.
Vertical Pos.
Size
Phase

Backlight Adjust the backlight of the screen

Colour Range 0 – 255
16 – 235

OSD menu

OPTION

OSD Language Selects OSD language

Restore Factory Default Adjusts the parameters as factory

Blending OSD window transparency

Low
Middle
High
Off

OSD Duration Adjusts the time that the OSD menu window remains on screen

Software Update (USB) Used for firmware upgrade

Mirror

0: Image with no flip
1: Vertical flip
2: Horizontal flip
3: Rotate

AHnet protocol

COMMUNICATIONS PROTOCOL

Communication	RS422
Connection	RJ45
Wiring	CAT-5

SPEED & CONFIGURATION

Baud Rate	38400
Data Bits	8
Parity	None
Stop Bits	1

WIRING DIAGRAM

1	Data TX +
2	Data TX -
3	Data RX +
4	NC
5	NC
6	Data RX -
7	NC
8	NC



RJ-45

CONNECTION

Pins 1 & 2 The units respond

Pins 3 & 6 The units receive instructions

Protocol to control the monitor by addressable RS422 bus.
You can connect up to 30 monitors on the same RS422 bus.
You can use a AH Interface Ethernet, to control the RS422 bus.
The units should have a set address and the address must start by 1.
Maximum cable length between ends, 500m/1640 ft.



AHnet protocol

AHnet PROTOCOL

Using 5 bytes communication:

BYTE 0	START BYTE
BYTE 1	ADDRESS BYTE
BYTE 2	COMMAND BYTE
BYTE 3	VALUE 1
BYTE 4	VALUE2

COMMANDS

COMMAND	DESCRIPTION	RESPONSE
FA XX 01 00 00	GO DOWN, BOTTOM 	FB XX 01 00 00
FA XX 01 01 00	GO UP + INCLINATION 	FB XX 01 01 00
FA XX 01 03 00	MONITOR 90° 	FB XX 01 03 00
FA XX 02 01 00	SCREEN ON	FB XX 02 01 00
FA XX 02 00 00	SCREEN OFF	FB XX 02 00 00
FA XX 03 00 00	INPUT SELECT DVI 1	FB XX 03 00 00
FA XX 03 01 00	INPUT SELECT DVI-A	FB XX 03 01 00
FA XX 03 03 00	INPUT SELECT DVI 2	FB XX 03 03 00
FA XX 04 01 00	BUTTON LOCK	FB XX 04 01 00
FA XX 04 00 00	BUTTON UNLOCK	FB XX 04 00 00
FA XX 14 00 00	INQUIRY CONTROL BYTE	FB XX 14 CB1 CB2

- XX Number of the monitor address.
Up to 30 monitors for each RS422 BUS
- CB1 Response in 8 bits of the monitor status
- CB2 Response in 8 bits of the monitor status

AHnet protocol

PICTURE COMMANDS

COMMAND	DESCRIPTION	RESPONSE
FA XX 15 00 00	ASK FOR BACKLIGHT LEVEL	FB XX 15 00 ZZ
FA XX 16 00 00	ASK FOR CONTRAST LEVEL	FB XX 16 00 ZZ
FA XX 17 00 00	ASK FOR BRIGHTNESS LEVEL	FB XX 17 00 ZZ

XX Number of the monitor address.
Up to 30 monitors for each RS422 BUS

ZZ Level of the function selected (00 – 99 Dec)

COMMAND	DESCRIPTION	RESPONSE
FA XX 15 01 ZZ	SET BACKLIGHT LEVEL	FB XX 15 01 ZZ
FA XX 16 01 ZZ	SET CONTRAST LEVEL	FB XX 16 01 ZZ
FA XX 17 01 ZZ	SET BRIGHTNESS LEVEL	FB XX 17 01 ZZ



XX Number of the monitor address.
Up to 30 monitors for each RS422 BUS

ZZ Level of the function selected (00 – 99 Dec)

To send an order to all the monitors, you must use the address F8

AHnet protocol

CB1

BITE	7	6	5	4	3	2	1	0
			1	1	0	1		
			0	1	0	1		
			1	0	0	1		
SCREEN ON							1	
SCREEN OFF							0	
DVI-A	0	0						
DVI-1	0	1						
DVI-2	1	1						
PROTECTION STOP								1
MONITOR OK								0

CB2

BITE	7	6	5	4	3	2	1	0
BUTTON LOCK								1
BUTTON UNLOCK								0

Input Signals

AH15D3 HDGA, AH17D3 HDGA, AH19D3 HDGA, AH22D3 16GA

RESOLUTION	Horizontal freq (KHz)	Vertical freq (Hz)	Scanning type
800x600@60Hz	37.879	60.317	Progressive
800x600@72Hz	48.077	72.188	Progressive
800x600@75Hz	46.875	75.000	Progressive
1024x768@60Hz	48.363	60.005	Progressive
1024x768@70Hz	56.476	70.070	Progressive
1024x768@75Hz	60.023	75.030	Progressive
1280x720@60Hz	44.772	59.855	Progressive
1360x768@60Hz	47.72	59.799	Progressive
1280x1024@60Hz	63.981	60.020	Progressive
1600x1200@60Hz	75.000	60.00	Progressive
1680x1050@60Hz	64.742	59.946	Progressive
1920x1080@60Hz	66.647	59.98	Progressive

Information on Disposal for users of waste Electrical & Electronic equipment



This symbol on the products and/or accompanying documents means that used electrical and electronic products should not be mixed with general household waste.

For proper treatment, recovery and recycling, please take these products to designated collection points, where they will be accepted on a free of charge basis. Alternatively, in some countries you may be able to return your products to your local retailer upon the purchase of an equivalent new product.

Disposing of this product correctly will help to save valuable resources and prevent any potential negative effects on human health and the environment which could otherwise arise from inappropriate waste handling. Please contact your local authority for further details of your nearest designated collection point.

Penalties may be applicable for incorrect disposal of this waste, in accordance with national legislation.

For business users in the European Union

If you wish to discard electrical and electronic equipment, please contact your dealer or supplier for further information.

Information on disposal in countries outside the European Union

This symbol is only valid in the European Union.

If you wish to discard this product, please contact your local authorities or dealer and ask for the correct method of disposal.

Product Warranty

Albiral Display Solutions S.L WARRANTY - Valid from January 2016

This warranty covers the original product purchase for a period of **24 months** from the date of purchase.

GENERAL WARRANTY TERMS

A) Parts. During the above mentioned warranty period, the replacement of any electronic and mechanical parts against any defects in manufacturing. The warranty does not cover any faulty electronic and/or mechanical components arising from incorrect installation, unauthorized modification, and inadequate transport or as a result of atmospheric phenomenon.

B) Labour. Albiral Display Solutions S.L. covers labour costs for replacement of any defective parts (in accordance to paragraph A) during the period of this warranty.

C) Transport costs.

I) In the case that a manufacturing defect occurs within 30 days after the purchase date, both freight and insurance will be paid by Albiral Display Solutions, S.L. Albiral Display Solutions S.L. will not be responsible for the damages caused by transportation if the customer does not inform in writing when receiving the goods.

II) After 180 days of the purchase date, both freight and insurance costs will be paid by the customer.

D) Albiral Display Solutions S.L. will not be responsible for the damages caused by transportation, when this one is paid by the customer.

E) The warranty is not valid if personnel other than the Authorised Service Centre have handled the product, if the product has been manipulated or warranty seals have been removed or manipulated.

F) The beneficiary of the warranty will have to return the product in its original packaging or in an appropriate package that will warrant no damages during transportation.

G) The warranty is not valid if the customer does not include a RMA form and a copy of the purchasing invoice.

Albiral Display Solutions S.L. recognizes all guaranteed user rights by all legal rules from its region, and in the absence of them, all established consumer rights by general law 26/84.

Albiral Display Solutions S.L.



ARTHUR HOLM

**Albiral
Display
Solutions**

Fàtima 25, Sant Hipòlit de Voltregà
08512 Barcelona – Spain
tel: +34 93 850 23 76 / 23 83
fax: +34 93 850 25 50 / 23 72
web: www.arthurholm.com
e-mail: marketing@arthurholm.com

Patents

	P 24821 RUPC
MU 1996 ES00	P 24821 USPC
MU 16997 ES00	P 27178 EPPC
MU 17180 ES00	P 27178 RUPC
MU 17301 ES00	P 27178 USPC
MU 17322 ES00	P 2784 EPPC
MU 17376 ES00	P 2784 RUPC
MU 1741 ES00	P 2784 USPC
MU 17445 ES00	P 27715 EPPC
P 248121 DEEP	P 28089 EP00
P 24821 ESEP	P 28089 PCEP
P 24821 FREP	P 28090 EP00
P 24821 GBEP	P 28090PCEP
P 24821 ITEP	P 28495 ES00