

# Dynamic3

HDCP compliant aluminum motorized foldable monitor

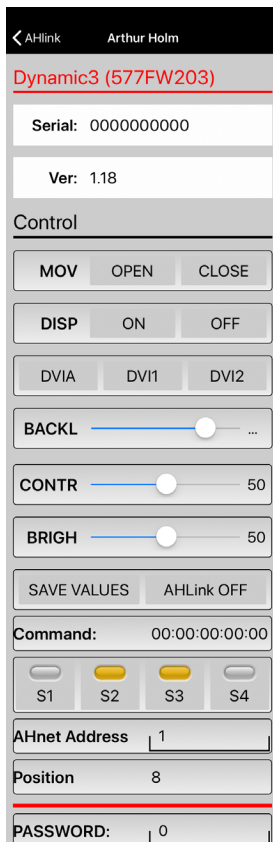
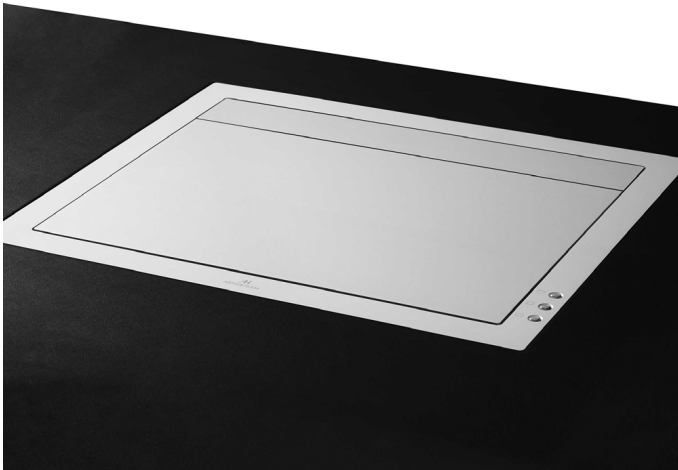

## Highlights

- Entirely built of aluminum
- Opens, folds down and rotates 180°
- Adjustable and memorisable tilt angle from 90 to 110°
- Synchronized tray lift movement
- Floating security sensor
- Energy saving design, low consumption video controller
- 2 DVI I/HDCP compliant
- RS422/RS485 I/O
- ISD: Interactive Setup Display for adjustments and service
- AHlink: Wireless connectivity for setup, adjustments and service
- AH-AMMC: Auto Mechanical Movement Calibration

AHlink : the App for setup, control and diagnose



ARTHUR HOLM

Albiral Display Solutions SL · Fàtima, 25 Sant Hipòlit de Voltregà 08512 Barcelona, Spain · +34 938 502 376 · marketing@arthurholm.com · www.arthurholm.com  
Arthur Holm is a registered brand of Albiral Display Solutions SL. Specifications subject to change without previous notice.

Technology serving Design

## General

Arthur Holm Dynamic3 is a motorized product range that folds and unfolds while keeping a low profile inside the working desk for a perfect integration in the furniture. The aluminum monitor housing rises and folds down.

The screen's lifting system automatically activates the elevation of a tray where keyboard and mouse can be placed. We have selected the best possible aluminum finishing specifications in the world, providing the maximum technical and visual performance and the screen is protected with an anti-reflective 2 side coating 3 mm black edged glass.

Dynamic3 is available from 15.6" to 21.5", with 2 DVI-HDCP compliant inputs and equipped with an interactive setup display (ISD) allowing the control, setup and diagnose of the monitors. Monitors provide RS-422 I/O allowing the remote control of movements, speeds, safety settings, brightness, contrast and backlight.

The monitor can also be adjusted and controlled via a wireless application: AHlink. The AHlink Android and iOS App allows the access to the setup and control menu and to get the serial number and firmware version without removing the monitor from the table. The Auto Mechanical Movement Calibration automatically adjust the speeds and the safety protection parameters. The use of the ERT-30 and ERT-60 enables an automatic individual address configuration of all the monitors in a meeting table.

## Technical Specifications

### Display

Size	FULL HD 18.5" TFT Active Matrix
Resolution	1920 (h) x 1080 (v)
Brightness	400 cd/m <sup>2</sup>
Contrast ratio	1500:1
Pixel	0.213 (h) x 0.213 (v) mm
Viewing angle	85°/85° (u/d) / 85°/85° (l/r)
Viewing area	408.96 (h) x 230.04 (v) mm
LED backlight lifespan	50,000 hrs
Response time	Tr 37 ms, Tf 3 ms
Temperature (operating/storage)	Operating 0°C – +40°C Storage -20°C – +60°C

### Materials

Monitor housing	Anodized Aluminum
Glass	AR 2 side with an anti-reflective coating on the glass surface. Thickness: 3.0 ± 0.3 mm
Cover plate	Anonized aluminum

### Connectivity

Input signal	DVI-I (1 input) – HDCP Compliant DVI-D (1 input) – HDCP Compliant
RJ45 CAT5 (with loop)	Addressable RS422 monitor control by AHnet protocol
GPI (SubD9)	Movements Control
USB	For service

### Control

RJ45, RS-422 (I/O)
Addressing
Termination switch
GPI
IR Remote control (monitor adjustments): 1/5

### Movement's Control

User interface on monitor	(Up/Down)
Remote	RS-422 I/O/GPI

### Electrical

Low voltage (external power supply)	100-240Vac, 47/63Hz, 12Vdc
Power consumption	55W

### Mechanical

Dimensions:	
Upper cover plate	542 x 435 x 4.1 mm [21.33" x 17.12" x 0.16"]
Housing below the table	528 x 413.40 x 102.5 mm [20.78" x 16.27" x 4.03"]
Weight	18.8 Kg / 37.47 Lbs
Shipping Dimensions:	
Weight	19.8 Kg / 43.6 Lbs
Shipping Box	582 x 506 x 212 mm [22.9" x 19.92" x 8.3"]

## Options

- Projected capacitive multi-touch screen
- Built-in DynamicTalk
- Integrated USB camera
- Integrated connectors on cover plate
- Retractable HDMI cable
- Keyboard and mouse
- DynamicLoop
- DynamicShare

## Finishes

- Laser engraved logo
- Underneath installation
- Black anodized
- Gold
- Bronze
- Painted

## Certifications

- CE
- FCC
- IECEE
- CB

## Warranty

- 2 years general warranty

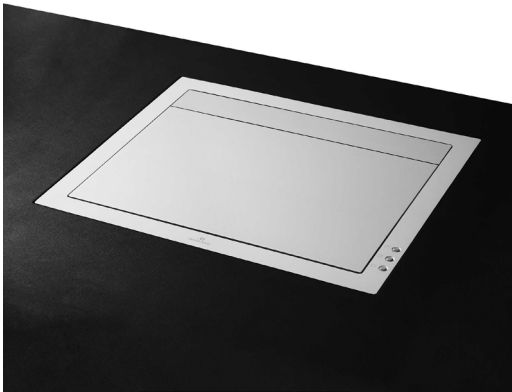

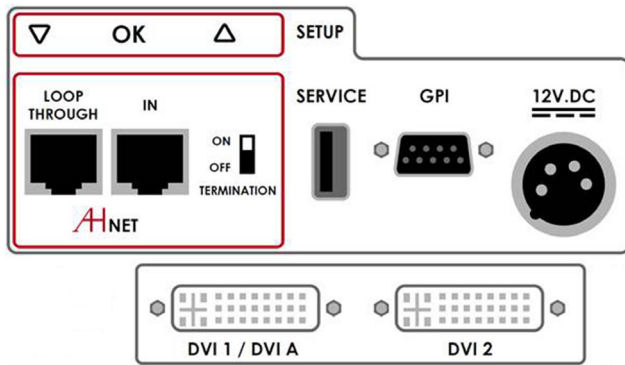

Interactive Setup Display

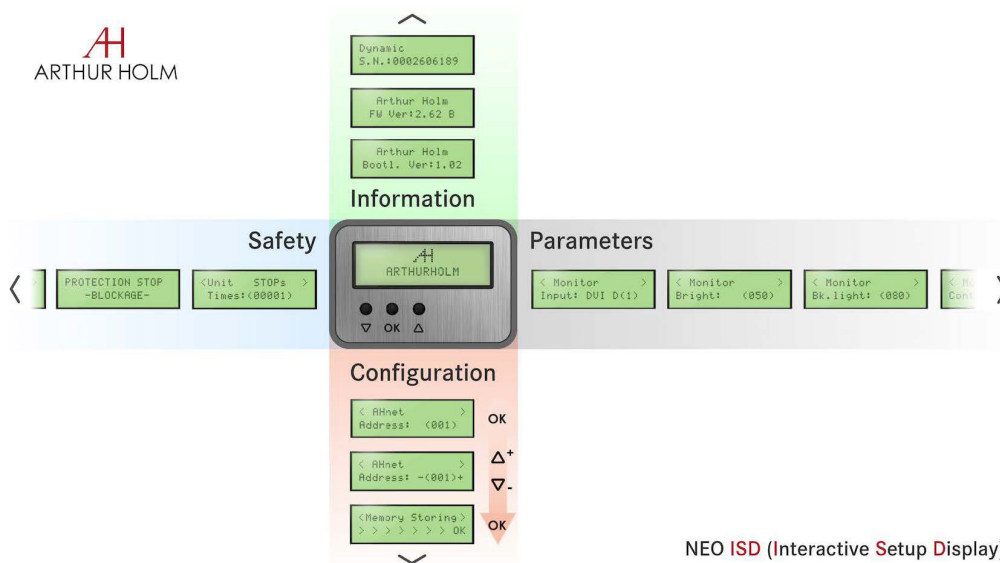

NEO ISD (Interactive Setup Display)

Consultants, architects and engineers specifications

Motorized foldable 18.5" Full HD professional monitor. The monitor housing shall be made of milled anodized aluminum and the screen shall be protected with anti-reflective 2 side coating black edged 3 mm glass. The monitor shall have a brightness of 400 cd/m2, a contrast ratio of 1500:1 and a backlight lifespan of 50,000 hours.

The monitor's opening mechanism shall activate automatically the rising of a synchronized aluminum tray covering the entire opening surface. The monitor shall be capable to be folded with the screen facing down. The monitor shall provide 2 DVI HDCP inputs by a licensed HDCP monitor manufacturer. The monitor shall provide an addressable RS-422 and an easy to read interactive setup display (ISD) to access the safety parameters, the setup of the speeds and the

control of the brightness, contrast and backlight and remote setup support and diagnostic. The monitor shall provide a dual safety system that detects obstructions causing the unit to stop through a floating security sensor. The monitor shall be able to run an auto-adjustment program to reset the factory security ratio between its factory movement speed and its protection parameters adapting the unit to the way it has been installed. The monitor shall provide a USB port for firmware upgrades.

The monitor shall be controlled by a wireless Android and iOS app providing information about the monitor's serial number, and providing access to the control and to the setup menu.

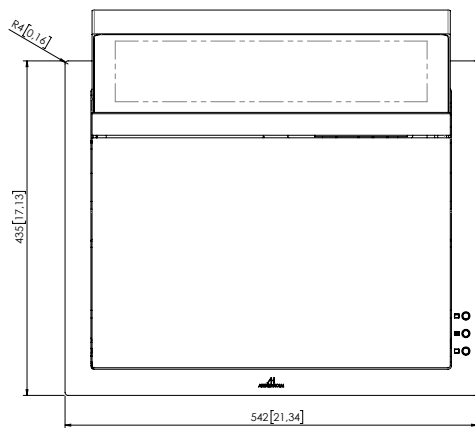
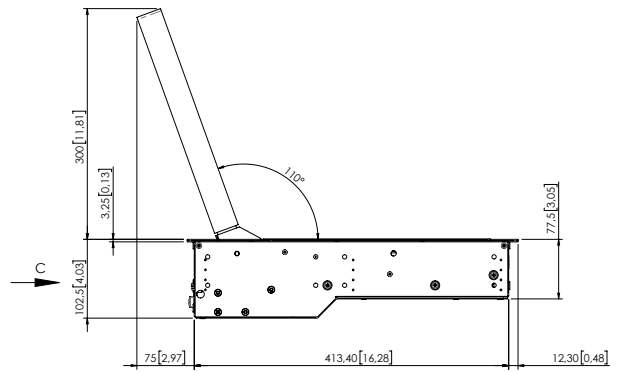
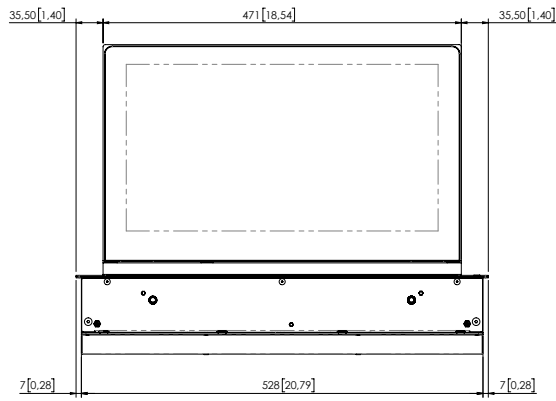

VIEW C

