



ARTHUR HOLM

AHDSR42W

# DynamicSpeaker

Motorized loudspeaker for desk integration

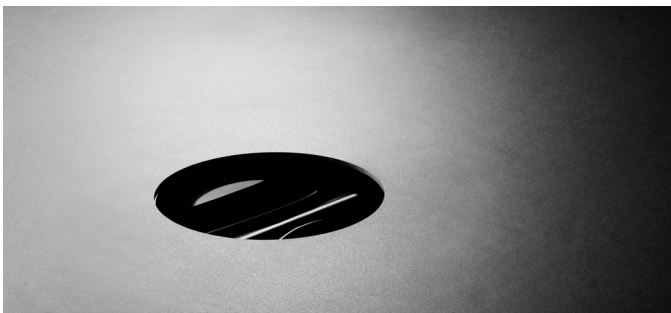
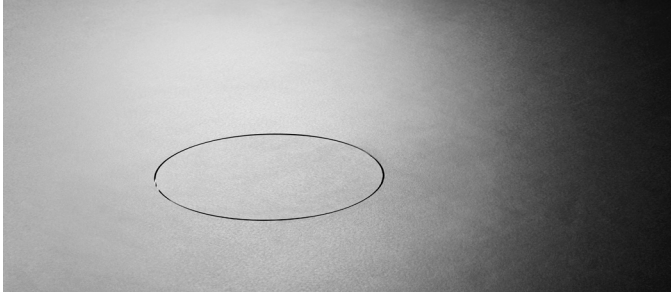

DynamicSpeaker\_UI: prepared for veneer

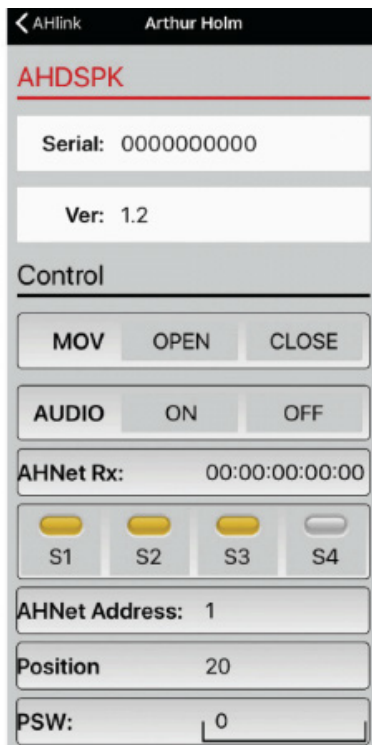

## Highlights

- Natural sound direction
- Speech intelligibility
- High gain before feedback
- Close proximity to user
- Limited audio pollution
- 360 degrees loudspeaker
- 4" 2-Way coaxial speaker, bass reflex
- 2 x 36W class-D integrated bi-amplifier
- Acoustic omnidirectional diffuser
- DSP integrated Balanced line input
- RS-422 controllable
- Near field audio reproduction
- Speech intelligibility enhancement
- Wooden speaker enclosure
- AHlink: Wireless connectivity for setup, adjustments, and control
- AH-AMMC: Auto Mechanical Movement Calibration

ARTHUR HOLM

Albiral Display Solutions SL · Fàtima, 25 Sant Hipòlit de Voltregà 08512 Barcelona, Spain · +34 938 502 376 · marketing@arthurholm.com · www.arthurholm.com  
Arthur Holm is a registered brand of Albiral Display Solutions SL. Specifications subject to change without previous notice.

Technology serving Design

## General

Arthur Holm DynamicSpeaker is a motorized loudspeaker for desk and furniture integration that brings flexibility and impressive audio quality with enhanced speech intelligibility to the meeting room or other rooms where quality audio is needed.

The compact, omnidirectional 360 degrees active speaker has a twin 36W Class-D integrated amplifiers and a two-way coaxial transducer that brings the audio to the dedicated area with its acoustic diffuser through its integrated DSP technology.

It can be controlled using the AHnet and its wireless AHlink app for control and setup. The Arthur Holm DynamicSpeaker is designed to be hidden when not in use with a smooth magical and elegant movement done without disturbing the audience.

## Connectivity

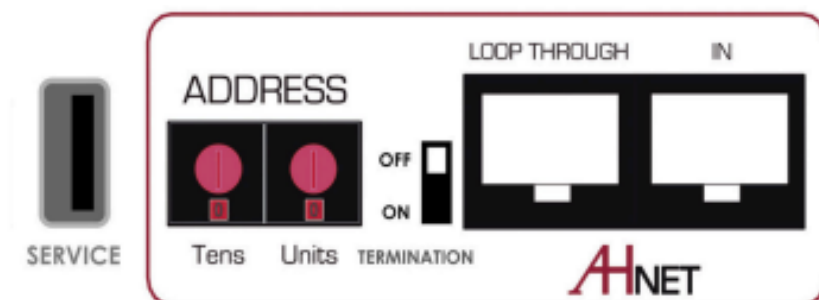
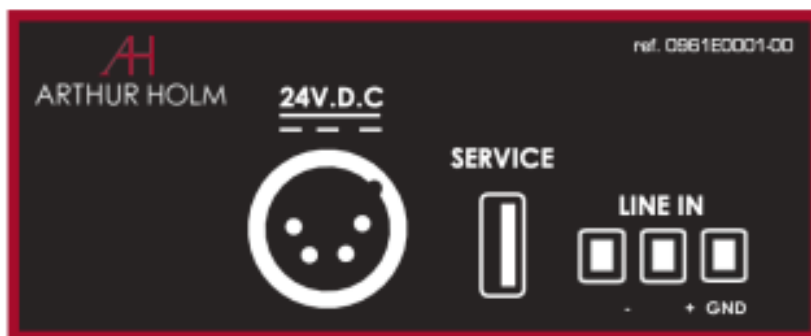

### ARTHUR HOLM

Albiral Display Solutions SL · Fàtima, 25 Sant Hipòlit de Voltregà 08512 Barcelona, Spain · +34 938 502 376 · marketing@arthurholm.com · www.arthurholm.com  
Arthur Holm is a registered brand of Albiral Display Solutions SL. Specifications subject to change without previous notice.

Technology serving Design

Technical Specifications

Audio Features

4" coaxial loudspeaker
Class-D 2-way bi-amplified
RMS power 2 x 36.5W
360° dispersion
Balanced analogue audio input. Level line +4dB
Internal DSP
Frequency response: 100Hz. - 10KHz. (± 7.5 dB)
Adjustable gain through AHnet (RS422 Protocol)
Mute function through AHnet (RS422 Protocol)

Materials

Brushed stainless steel
Steel
Aluminum
Wood

Finishing

Speaker driver mat black
Speaker diffuser mat black, non-reflecting
Cover plate in brushed stainless steel / mat black / white
Black housing

Connectivity

USB Port for software update
XLR-4 input

Engine

Control Up/Down	Capacitive touch control sensor on
RJ45 CAT6	Addressable RS422 control by AHnet protocol

Electrical

External power supply	100-240 Vac, 50/60Hz. 24VdC
Power consumption	90W

Mechanical

Case Dimensions:	
Upper cover plate	Ø 264 x 3 mm [10.39" x 0.11"]
Housing below the table	Ø 251 x 214,50 mm [9.88" x 8.44"]
Weight	8 Kg / 17.63 Lbs
Shipping Dimensions:	
Weight	8.5 Kg / 18.73 Lbs
Shipping Box	36,5 x 36,5 x 37 cm [14.37" x 14.37" x 14.56"]

Options

- Underneath installation
- Painted

Certifications

- CE
- FCC

Warranty

- 2 years general warranty

Consultants, architects and engineers specifications

The loudspeaker should be motorized to be hidden in a desk surface. The motorized active loudspeaker shall be two-way, in- surface system consisting of a 4" coaxial omnidirectional transducer mounted in a wooden ported enclosure with 2 x 36W class-D bi-amplifier and DSP technology integrated, omnidirectional acoustic diffuser. The cover plate shall be made of stainless steel. The System shall be controlled through AHnet and through AHlink (wireless app for control and set-up).

The input connection shall be made via a 4-pin lockable XLR connector, 2 E45 connectors with loop-through, 2 x USB and PCB block connectors.

The dispersion shall be 360° up to 10kHz. The on-axis frequency response shall be 100Hz-10kHz +/- 7dB and the loudspeaker shall produce a maximum SPL of 105dB peak measured at 1 metre. Power handling shall be 74W AES, 104W peak. The loudspeaker shall be equipped with two rotary switches for selection of address and set-ups, 2 x USB ports for firmware upgrades.

The mechanical movement shall be made using only one engine and a combination of a linear and circular movement shall move the transducer enclosure down, rotate it and lift up the transducer and the acoustic diffuser so the transducer is at level with the housing surface.

All measurements are taken with the speaker installed in a 1m x 1m wooden surface.

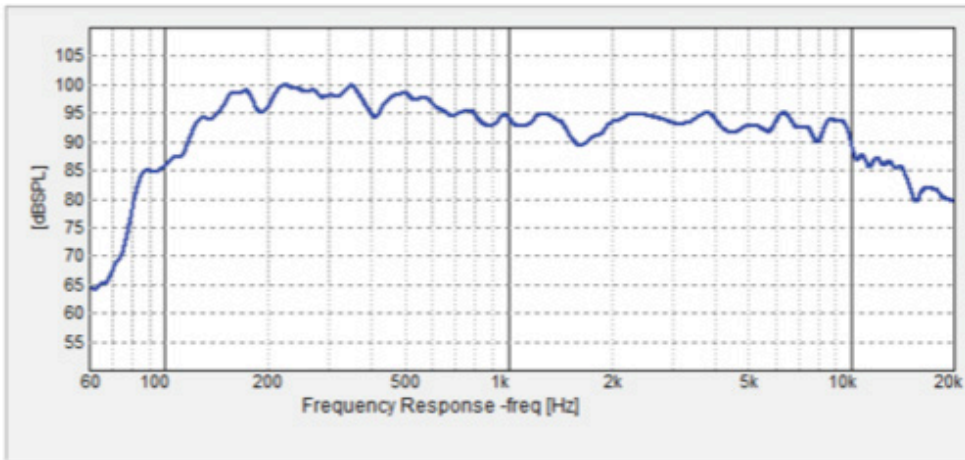

## HORIZONTAL



125Hz



250Hz

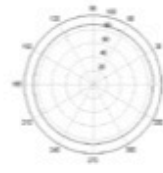

500Hz



1kHz

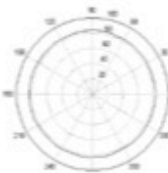

2kHz

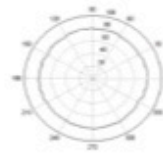

4kHz



8kHz

## POLAR PATTERNS

## VERTICAL



125Hz



250Hz



500Hz



1 kHz



2 kHz



4 kHz



8 kHz

ARTHUR HOLM

Albiral Display Solutions SL · Fàtima, 25 Sant Hipòlit de Voltregà 08512 Barcelona, Spain · +34 938 502 376 · marketing@arthurholm.com · www.arthurholm.com  
Arthur Holm is a registered brand of Albiral Display Solutions SL. Specifications subject to change without previous notice.

Technology serving Design

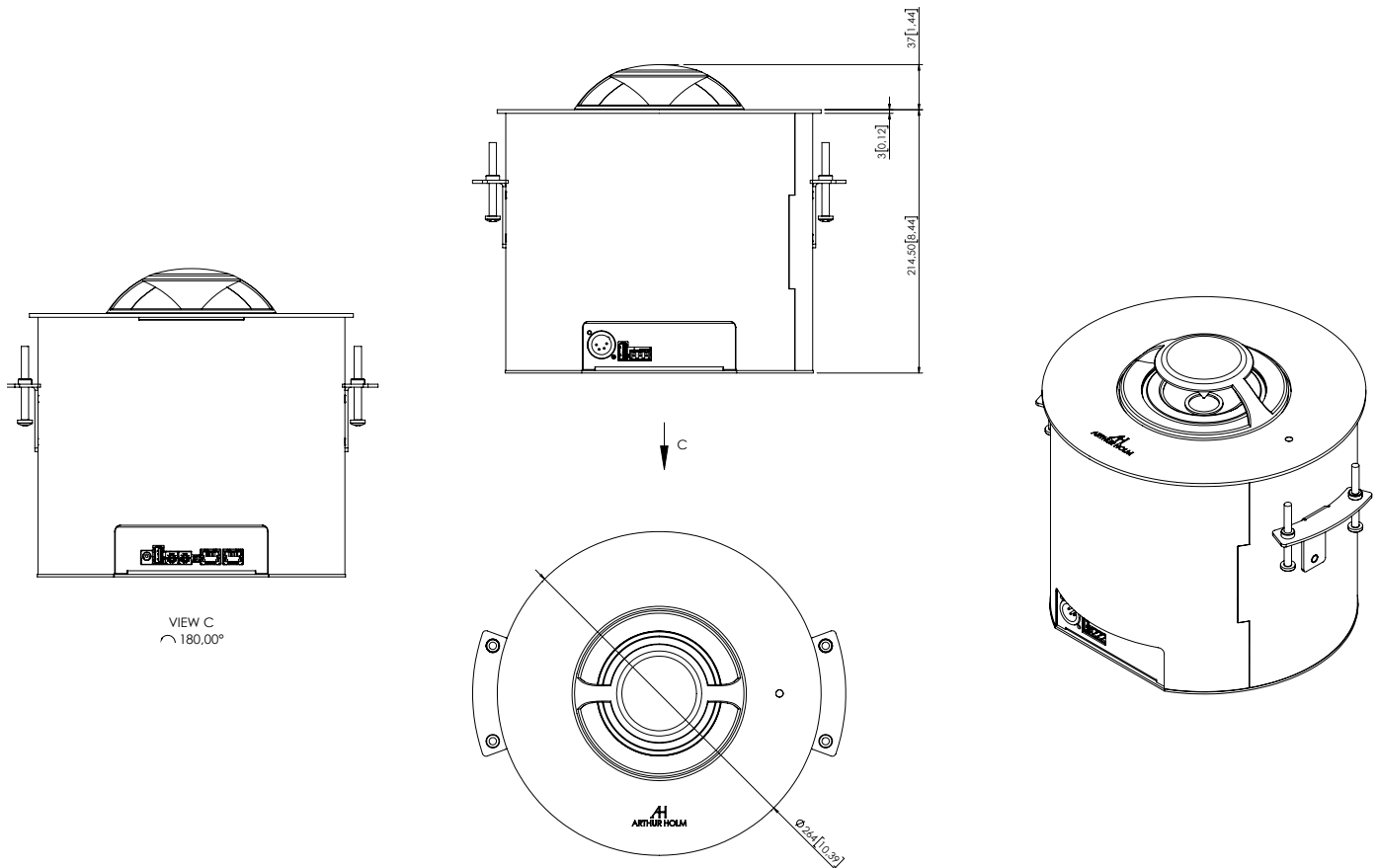

ARTHUR HOLM

Albiral Display Solutions SL · Fàtima, 25 Sant Hipòlit de Voltregà 08512 Barcelona, Spain · +34 938 502 376 · marketing@arthurholm.com · www.arthurholm.com  
 Arthur Holm is a registered brand of Albiral Display Solutions SL. Specifications subject to change without previous notice.

Technology serving Design